

Centros del triángulo (A)

Encuentra cada centro del triángulo dado.

1. - circuncentro

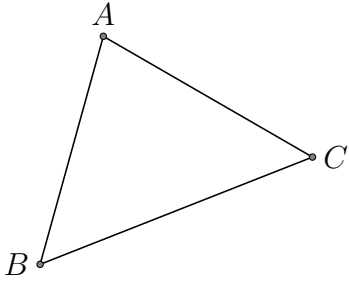

2. - circuncentro

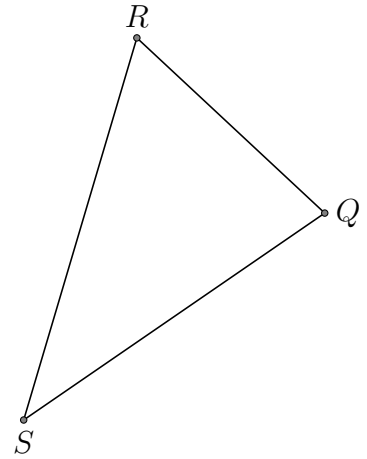

3. - circuncentro

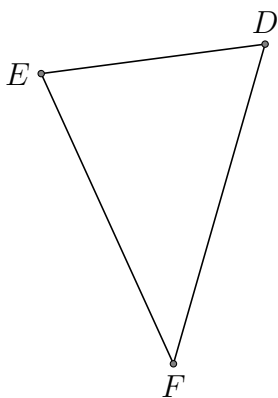

4. - circuncentro

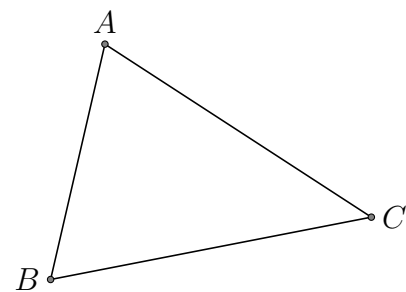

Centros del triángulo (A) Respuestas

Encuentra cada centro del triángulo dado.

1. - circuncentro

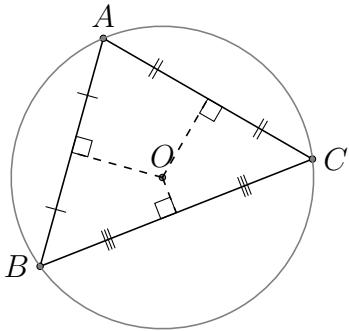

2. - circuncentro

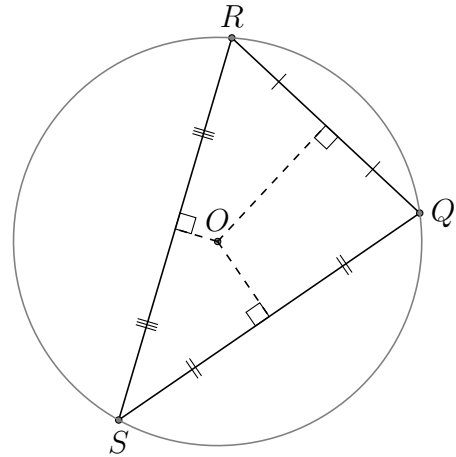

3. - circuncentro

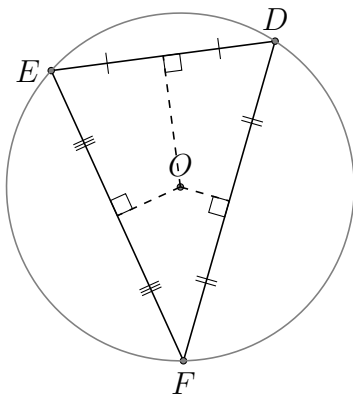

4. - circuncentro

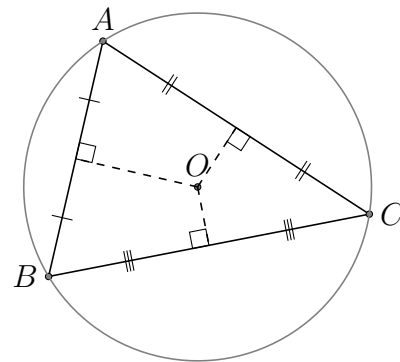

Centros del triángulo (B)

Encuentra cada centro del triángulo dado.

1. - circuncentro

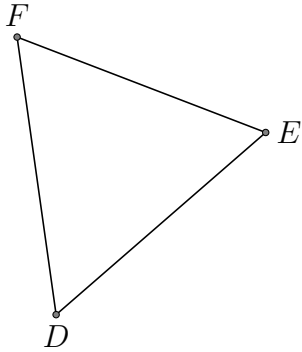

2. - circuncentro

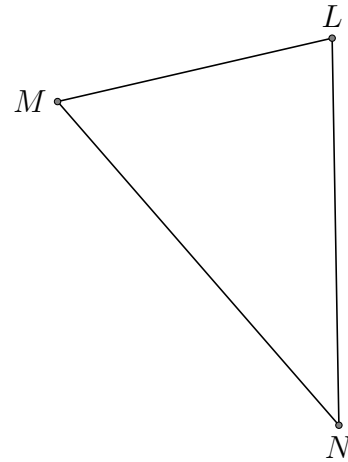

3. - circuncentro

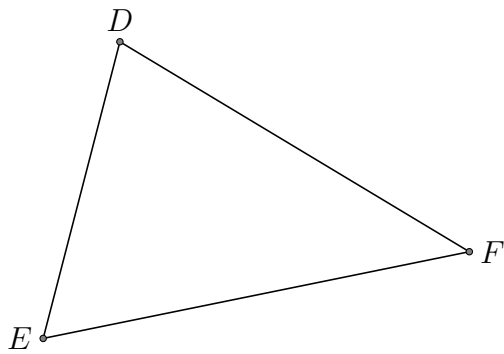

4. - circuncentro

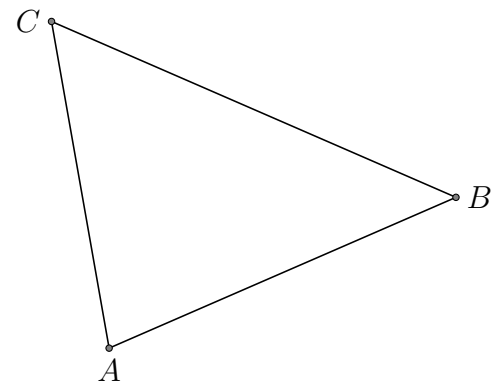

Centros del triángulo (B) Respuestas

Encuentra cada centro del triángulo dado.

1. - circuncentro

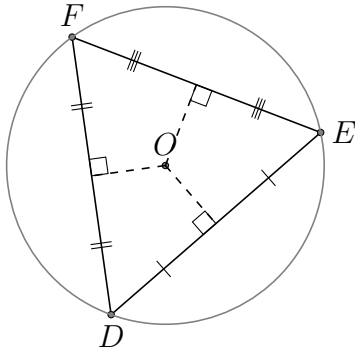

2. - circuncentro

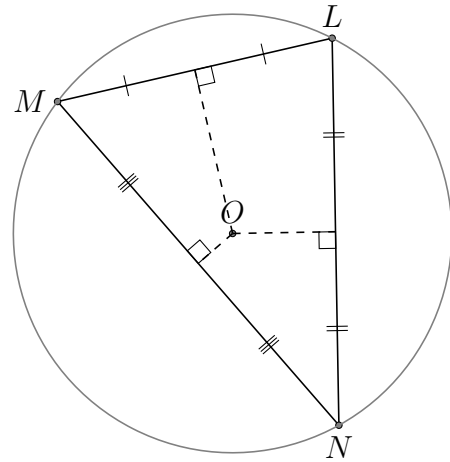

3. - circuncentro

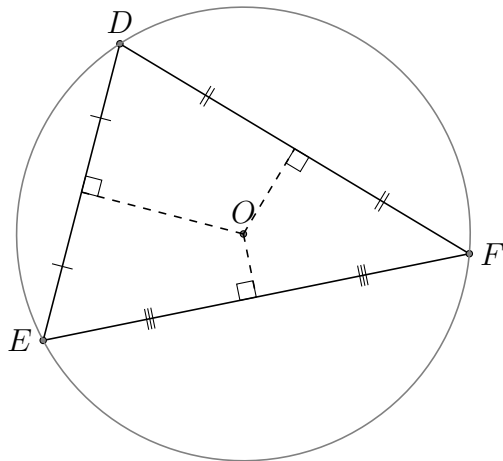

4. - circuncentro

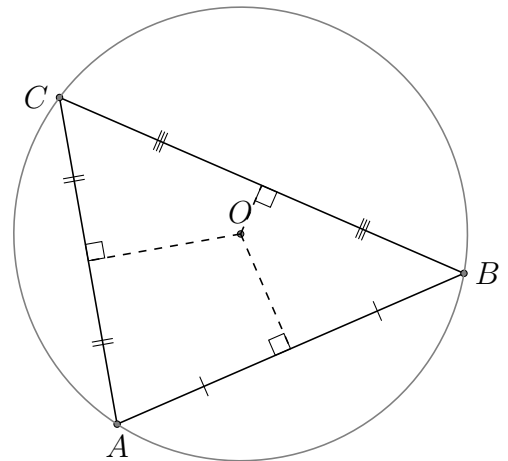

Centros del triángulo (C)

Encuentra cada centro del triángulo dado.

1. - circuncentro

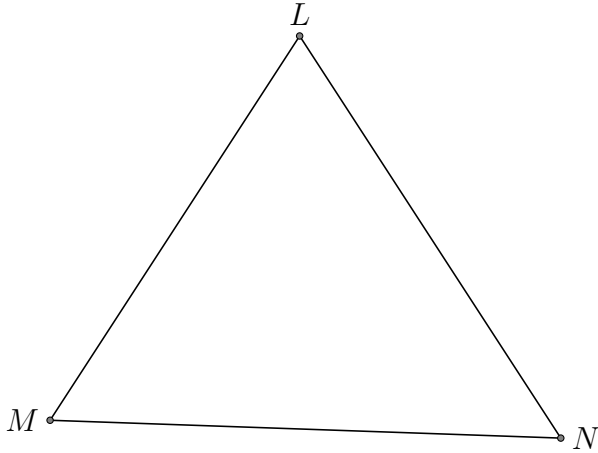

2. - circuncentro

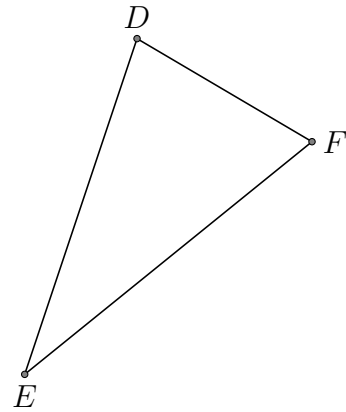

3. - circuncentro

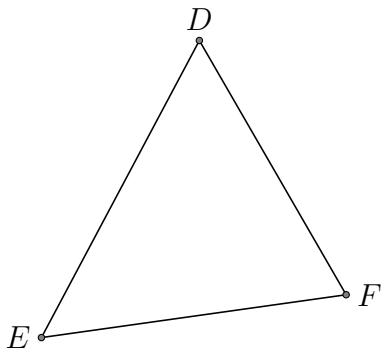

4. - circuncentro

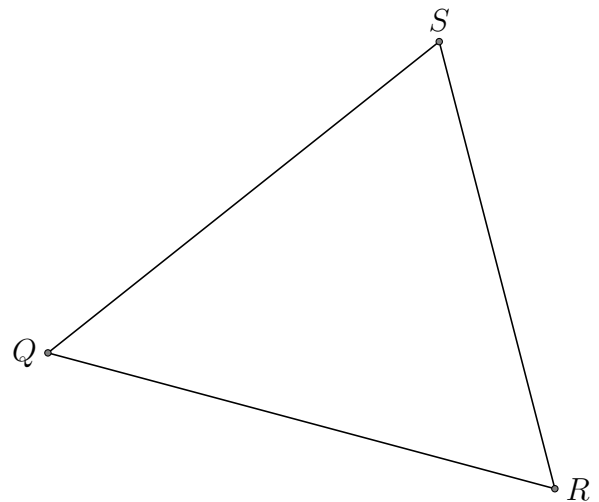

Centros del triángulo (C) Respuestas

Encuentra cada centro del triángulo dado.

1. - circuncentro

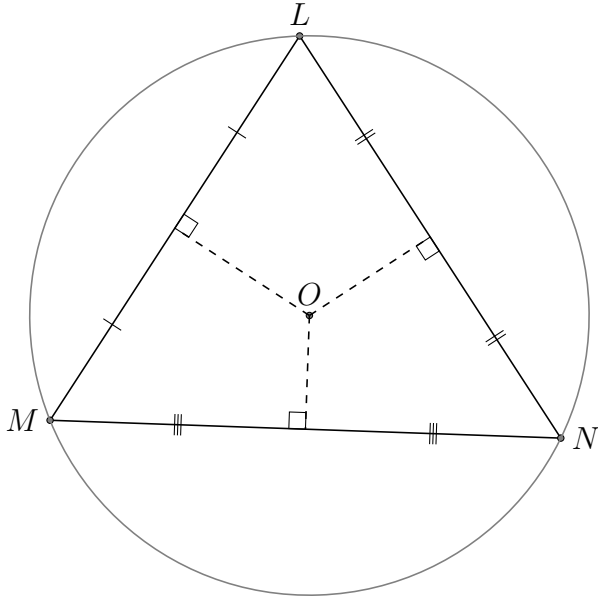

2. - circuncentro

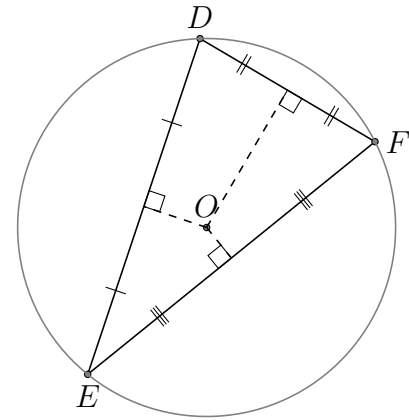

3. - circuncentro

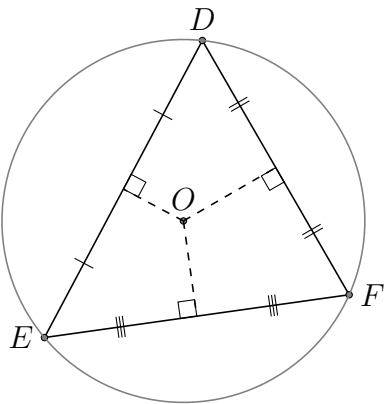

4. - circuncentro

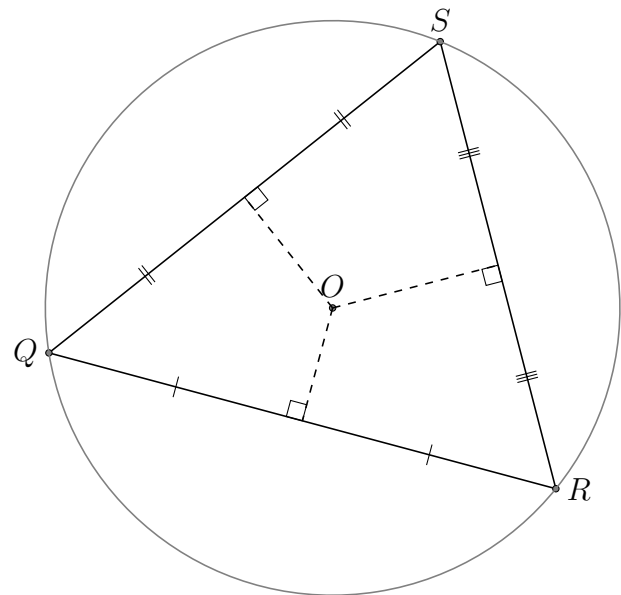

Centros del triángulo (D)

Encuentra cada centro del triángulo dado.

1. - circuncentro

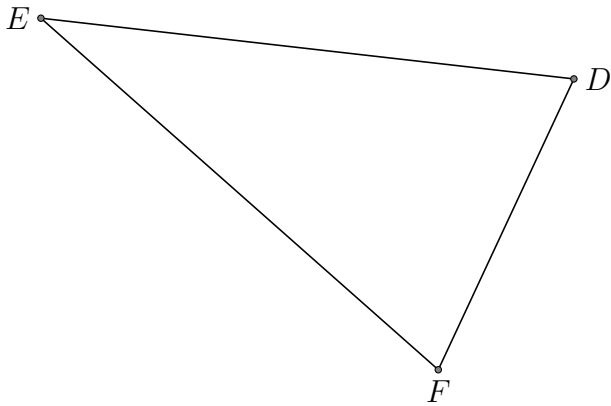

2. - circuncentro

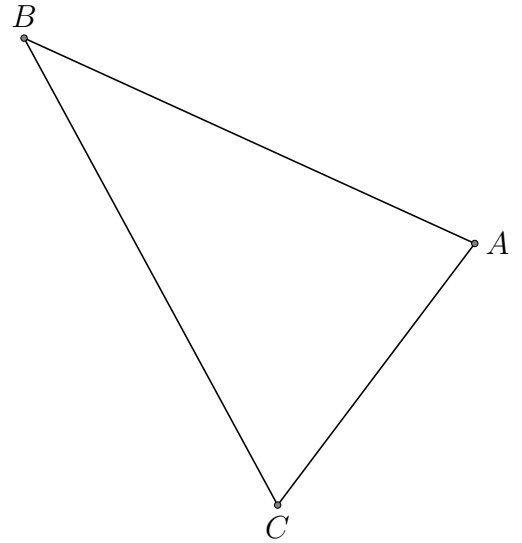

3. - circuncentro

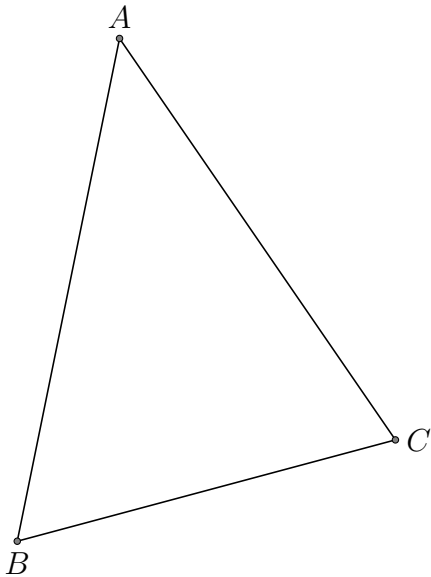

4. - circuncentro

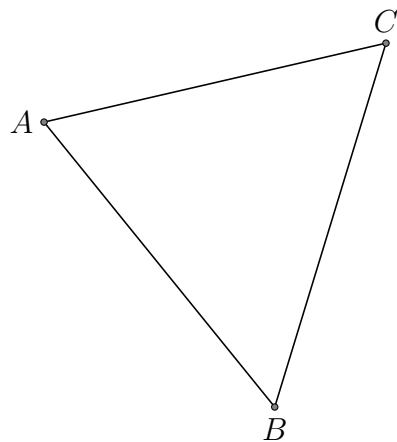

Centros del triángulo (D) Respuestas

Encuentra cada centro del triángulo dado.

1. - circuncentro

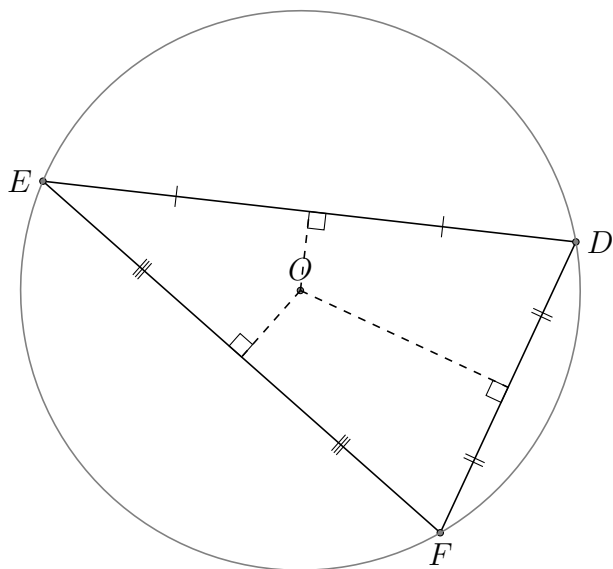

2. - circuncentro

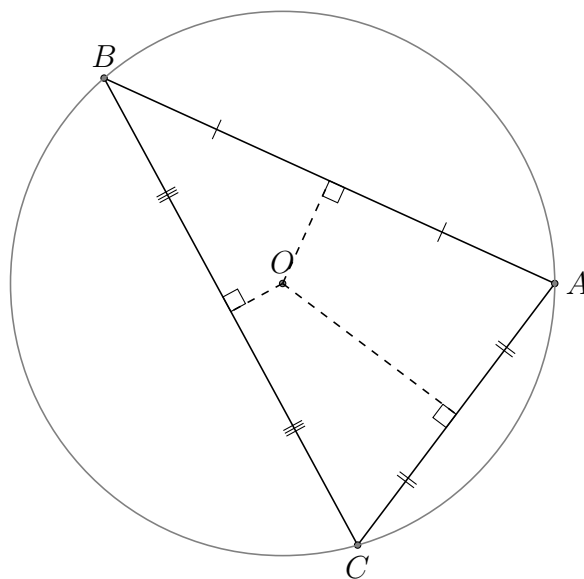

3. - circuncentro

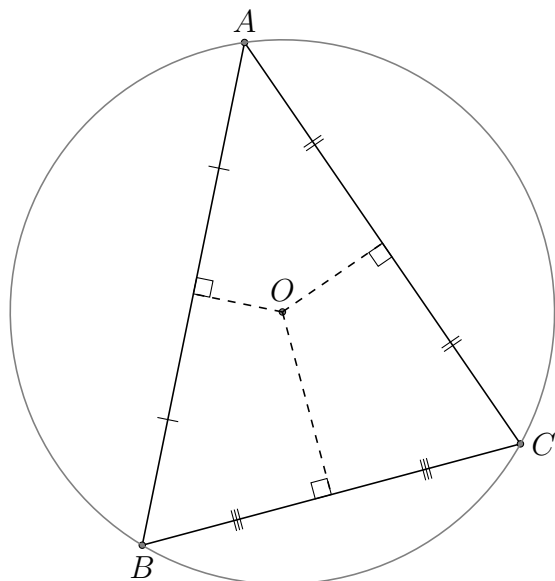

4. - circuncentro

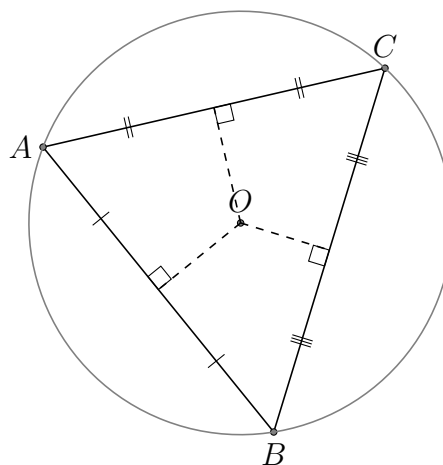

Centros del triángulo (E)

Encuentra cada centro del triángulo dado.

1. - circuncentro

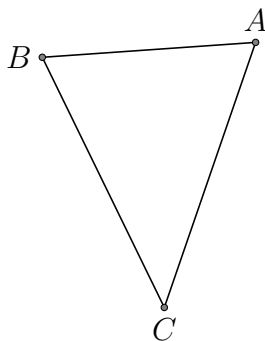

2. - circuncentro

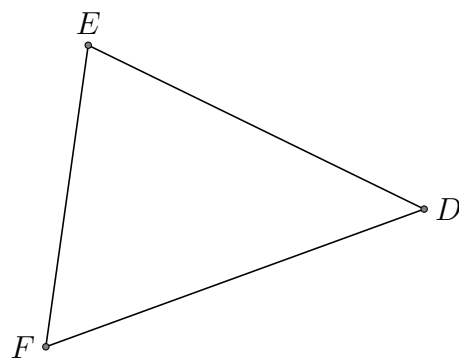

3. - circuncentro

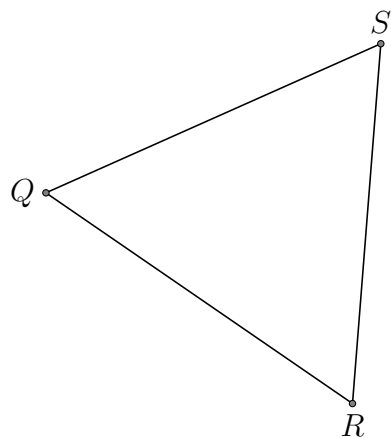

4. - circuncentro

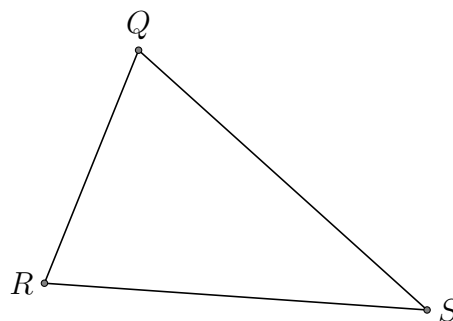

Centros del triángulo (E) Respuestas

Encuentra cada centro del triángulo dado.

1. - circuncentro

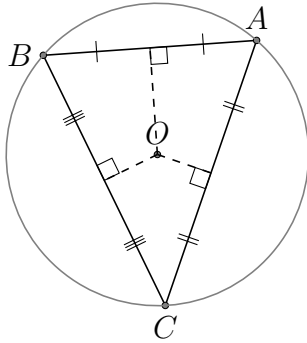

2. - circuncentro

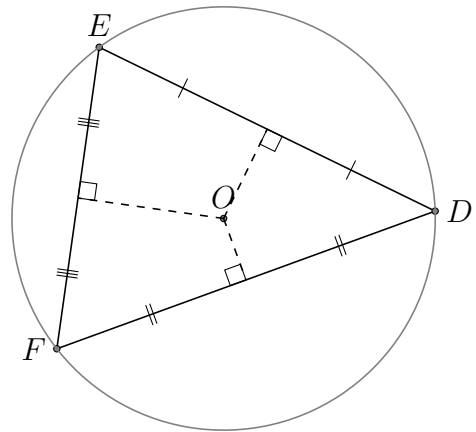

3. - circuncentro

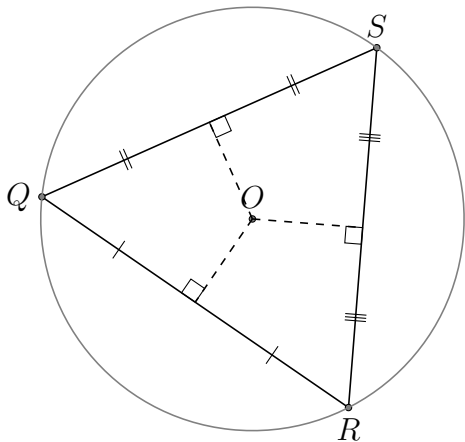

4. - circuncentro

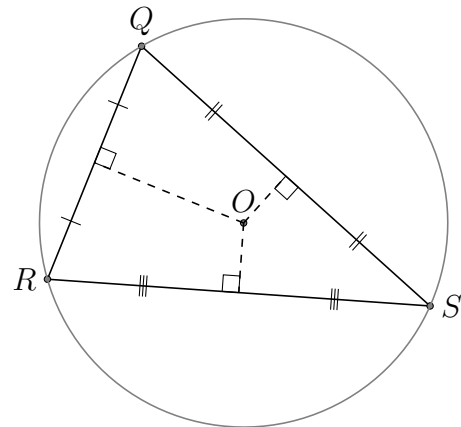

Centros del triángulo (F)

Encuentra cada centro del triángulo dado.

1. - circuncentro

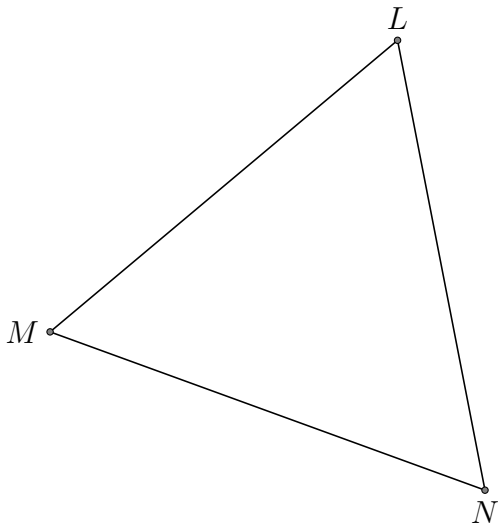

2. - circuncentro

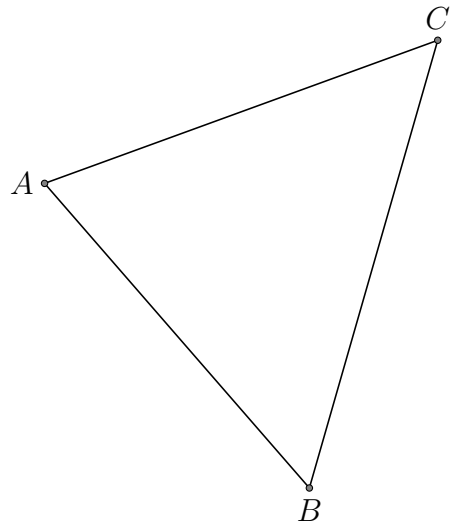

3. - circuncentro

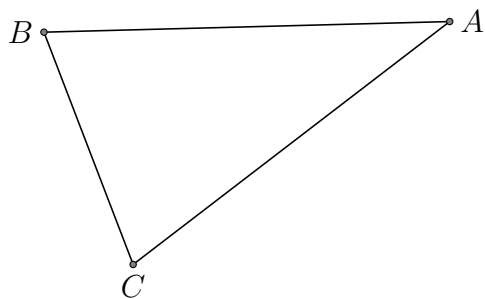

4. - circuncentro

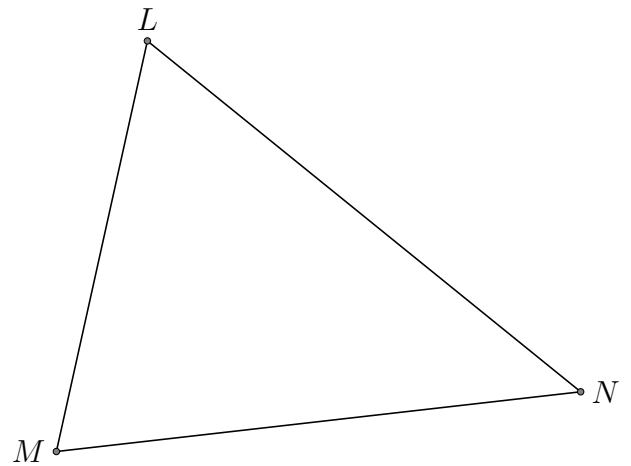

Centros del triángulo (F) Respuestas

Encuentra cada centro del triángulo dado.

1. - circuncentro

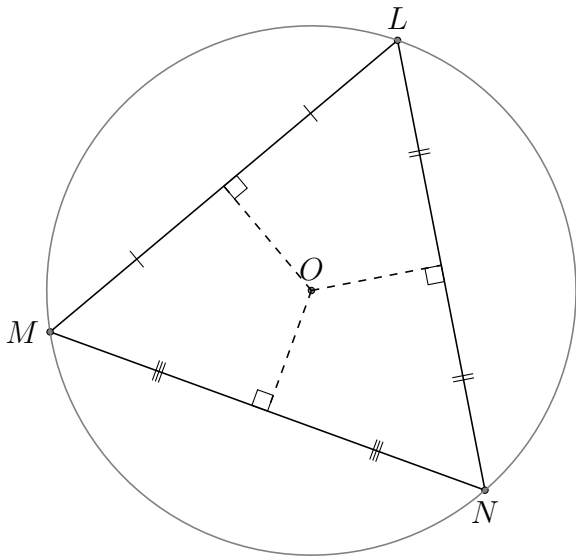

2. - circuncentro

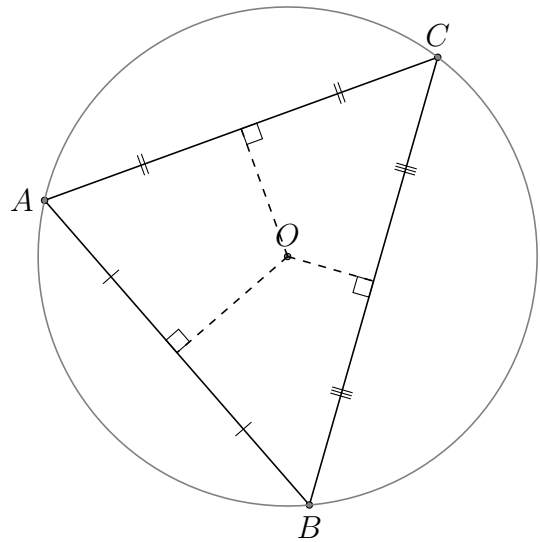

3. - circuncentro

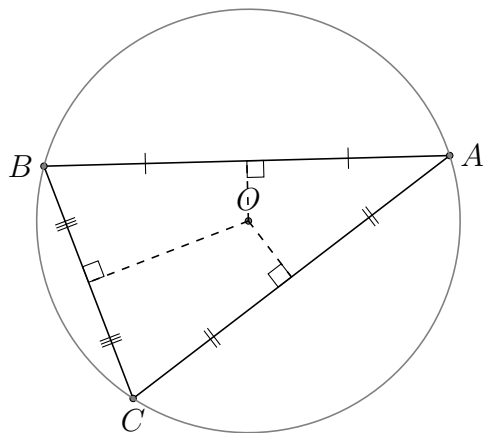

4. - circuncentro

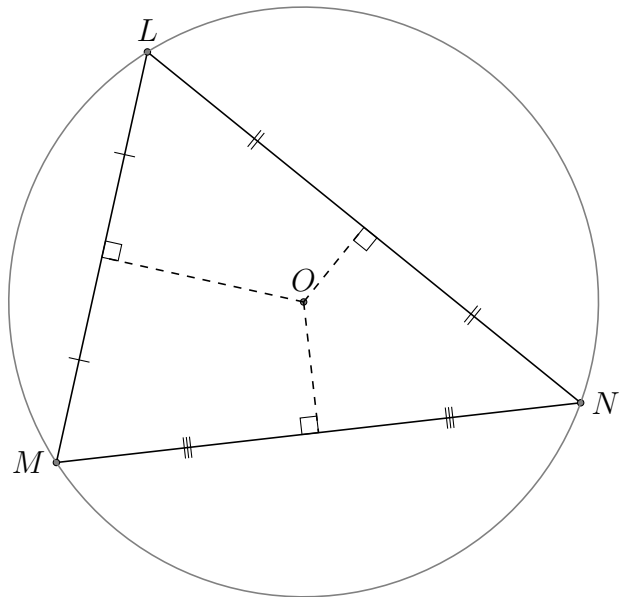

Centros del triángulo (G)

Encuentra cada centro del triángulo dado.

1. - circuncentro

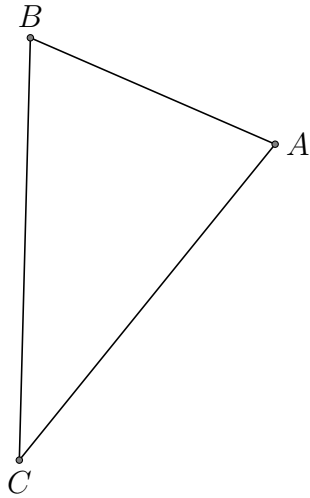

2. - circuncentro

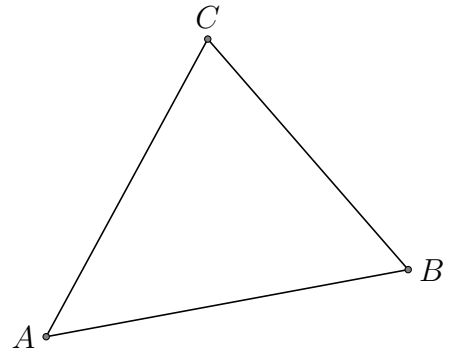

3. - circuncentro

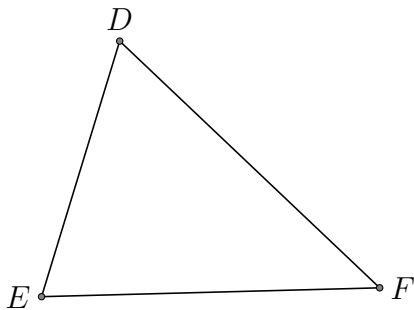

4. - circuncentro

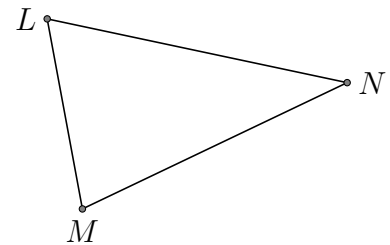

Centros del triángulo (G) Respuestas

Encuentra cada centro del triángulo dado.

1. - circuncentro

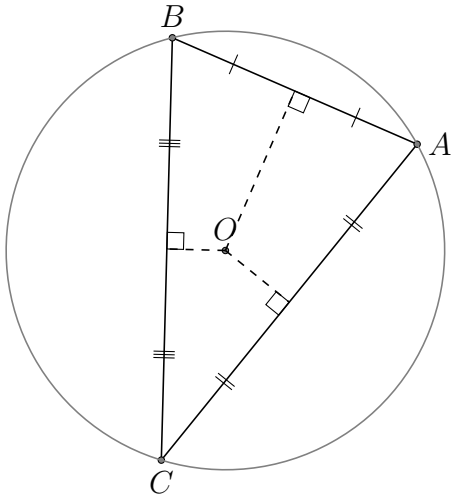

2. - circuncentro

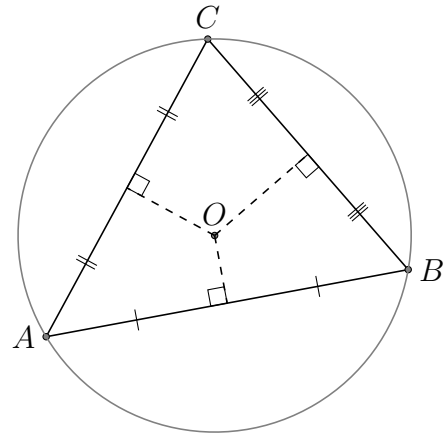

3. - circuncentro

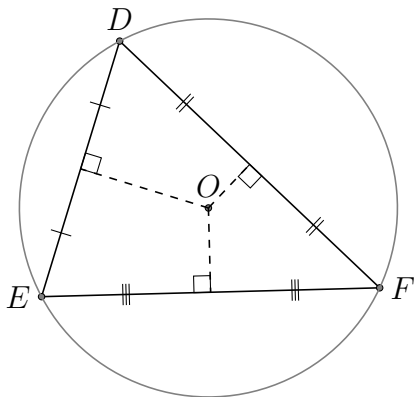

4. - circuncentro

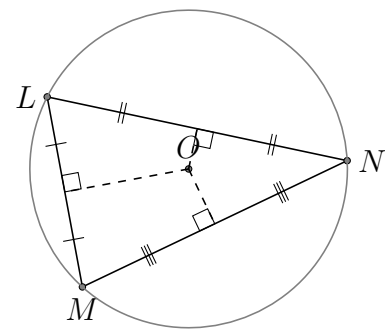

Centros del triángulo (H)

Encuentra cada centro del triángulo dado.

1. - circuncentro

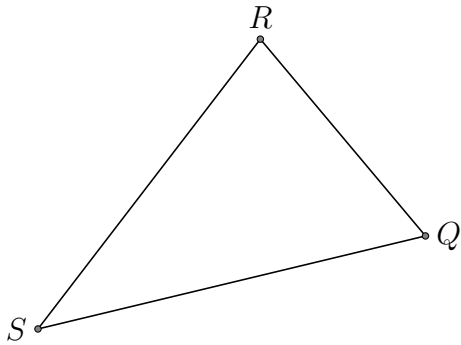

2. - circuncentro

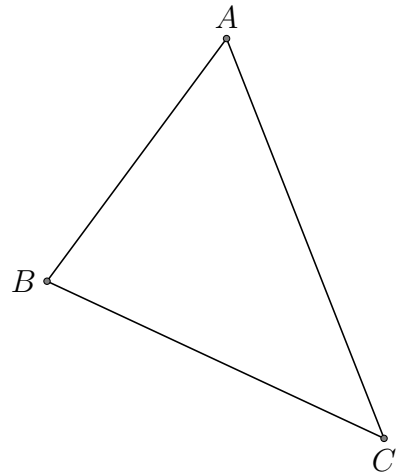

3. - circuncentro

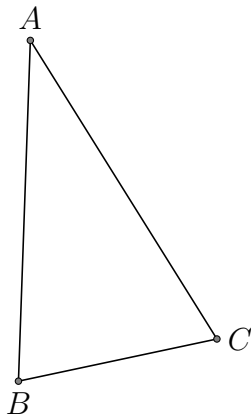

4. - circuncentro

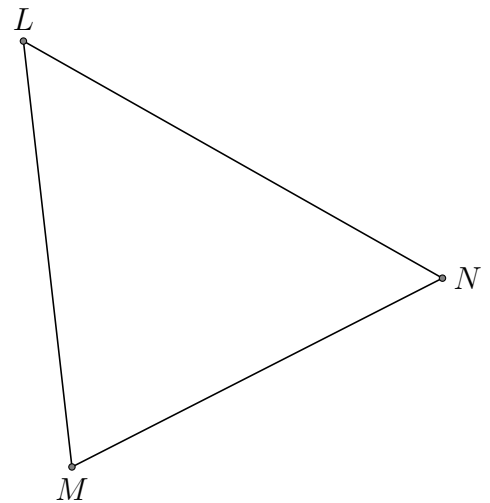

Centros del triángulo (H) Respuestas

Encuentra cada centro del triángulo dado.

1. - circuncentro

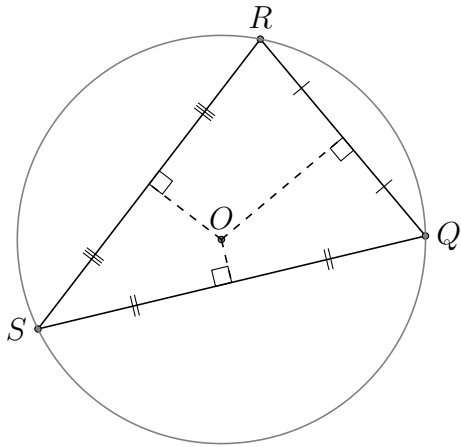

2. - circuncentro

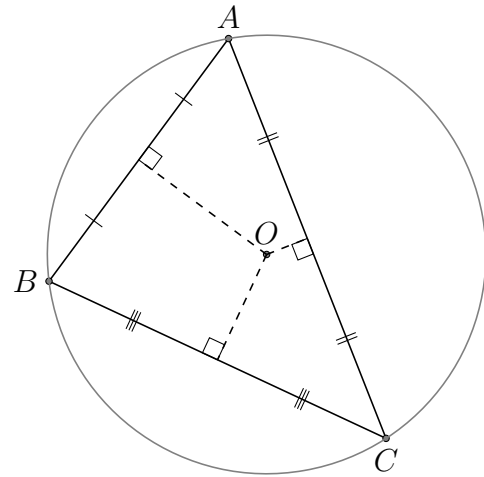

3. - circuncentro

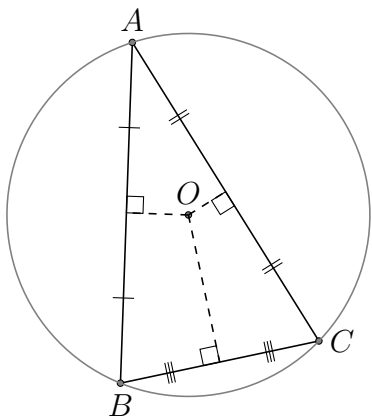

4. - circuncentro

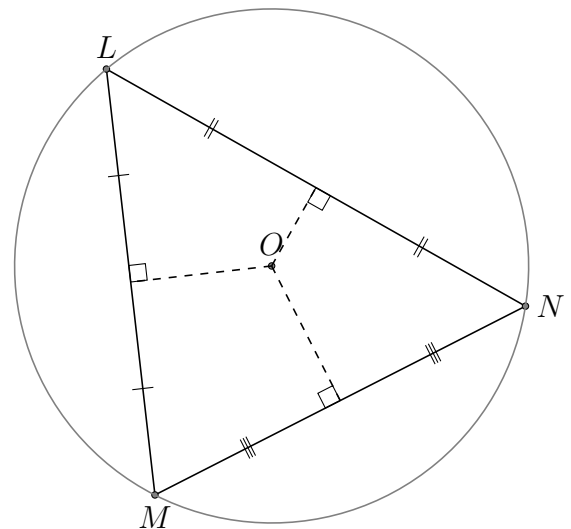

Centros del triángulo (I)

Encuentra cada centro del triángulo dado.

1. - circuncentro

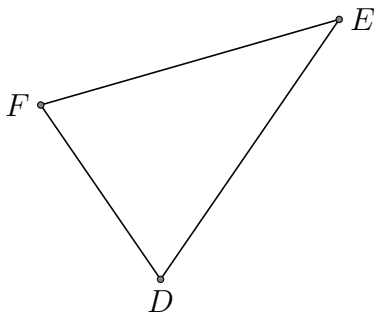

2. - circuncentro

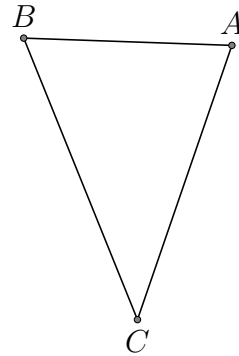

3. - circuncentro

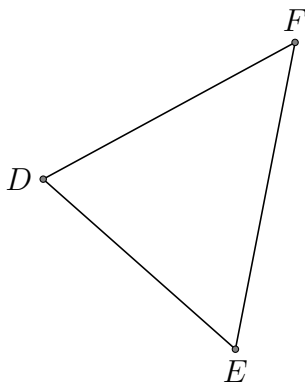

4. - circuncentro

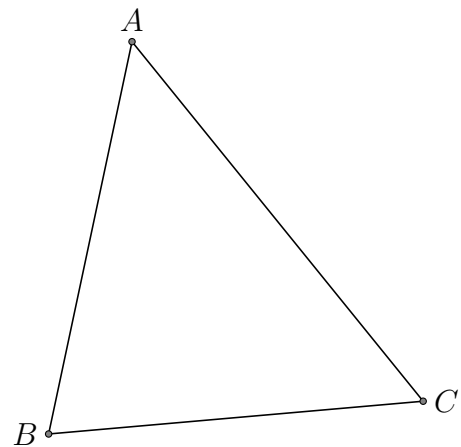

Centros del triángulo (I) Respuestas

Encuentra cada centro del triángulo dado.

1. - circuncentro

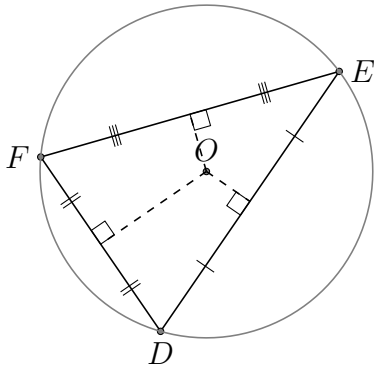

2. - circuncentro

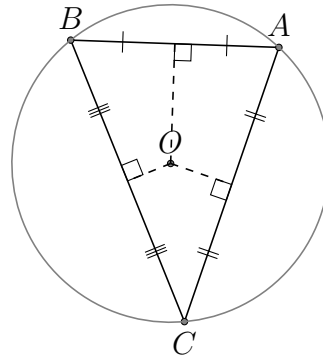

3. - circuncentro

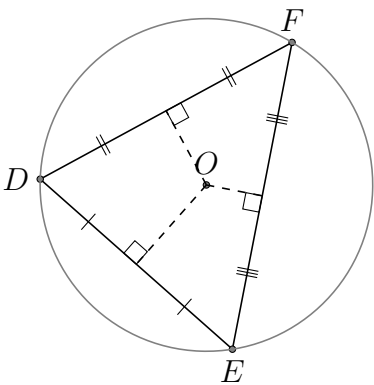

4. - circuncentro

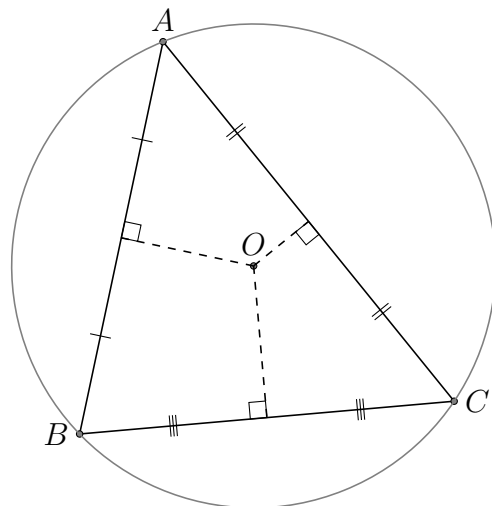

Centros del triángulo (J)

Encuentra cada centro del triángulo dado.

1. - circuncentro

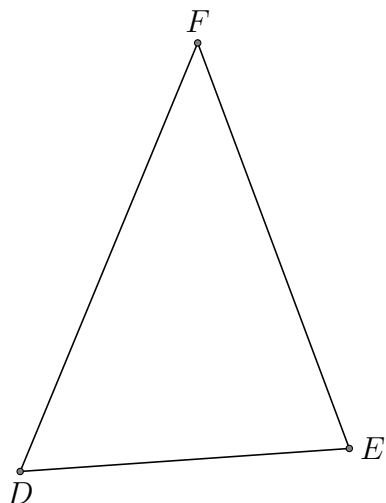

2. - circuncentro

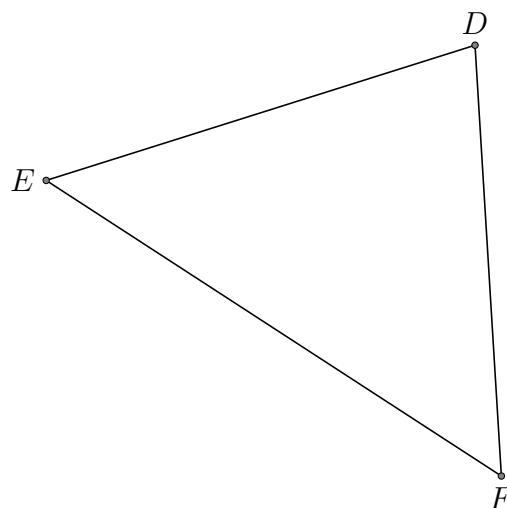

3. - circuncentro

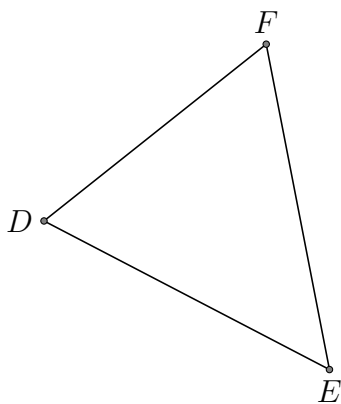

4. - circuncentro

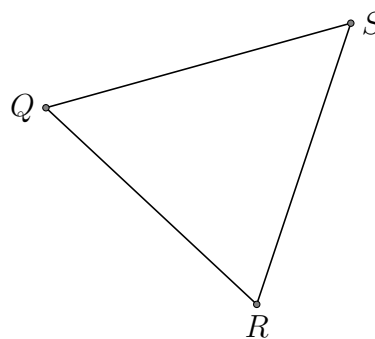

Centros del triángulo (J) Respuestas

Encuentra cada centro del triángulo dado.

1. - circuncentro

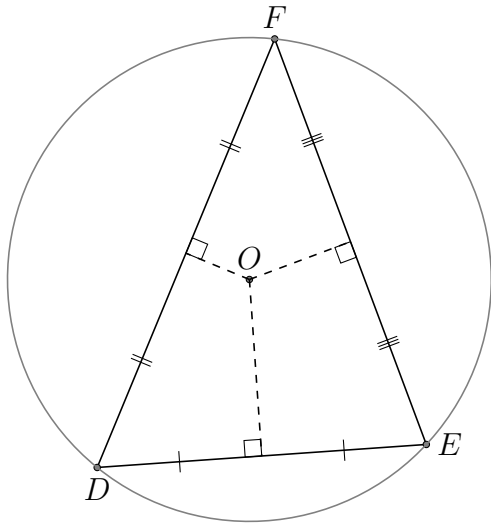

2. - circuncentro

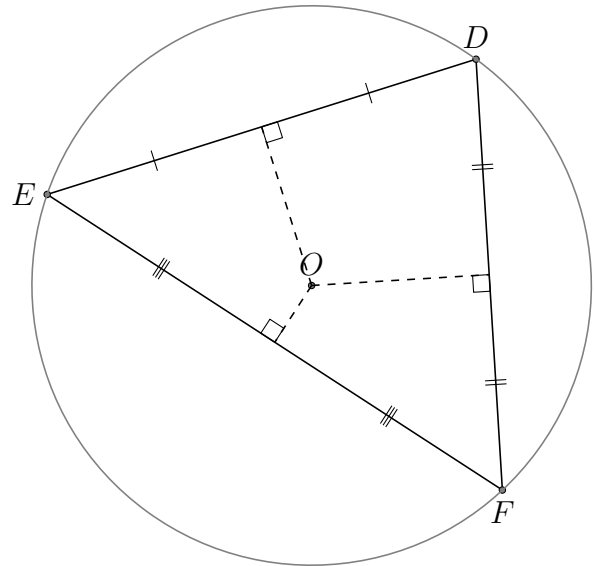

3. - circuncentro

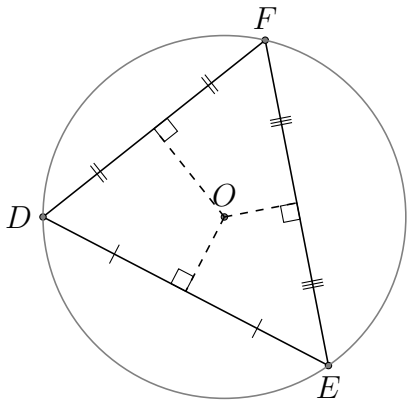

4. - circuncentro

