

# Problemas de Hallar Ángulos (A)

Complete los ángulos que faltan.

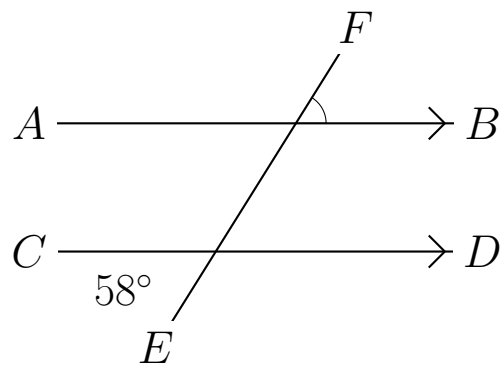
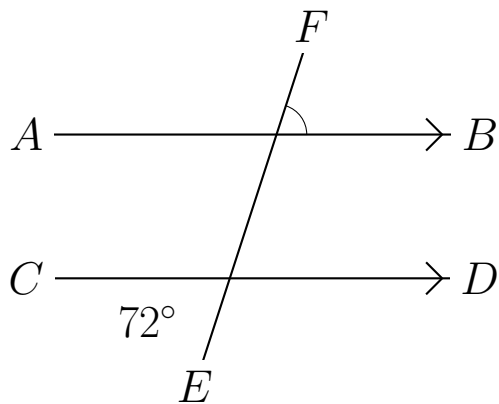
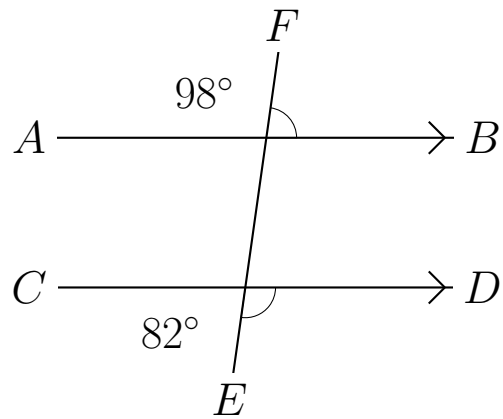
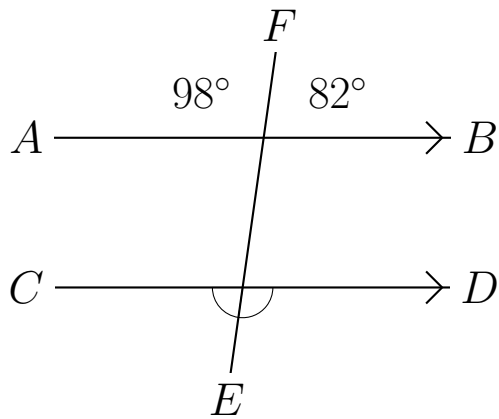
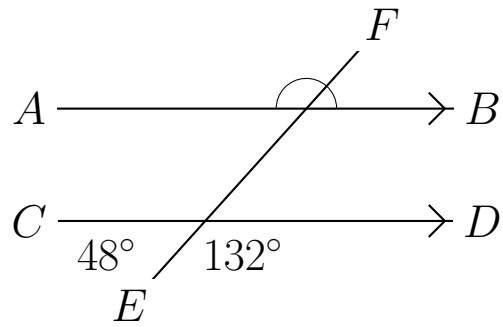
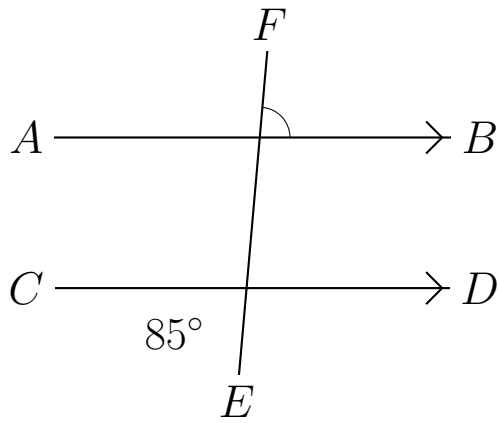

# Problemas de Hallar Ángulos (A) Respuestas

Complete los ángulos que faltan.

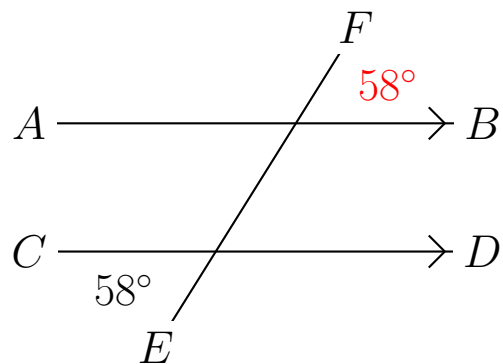
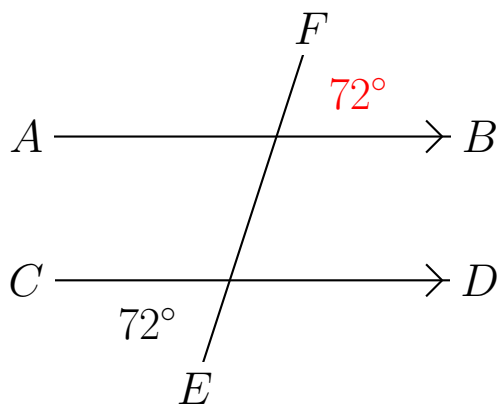
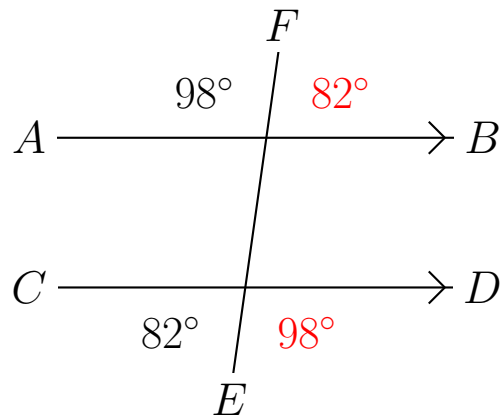
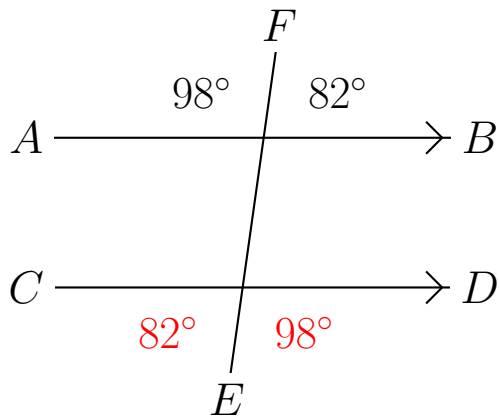
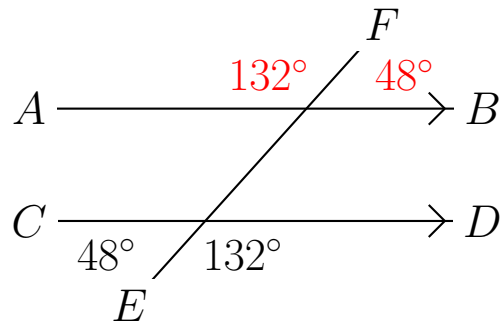
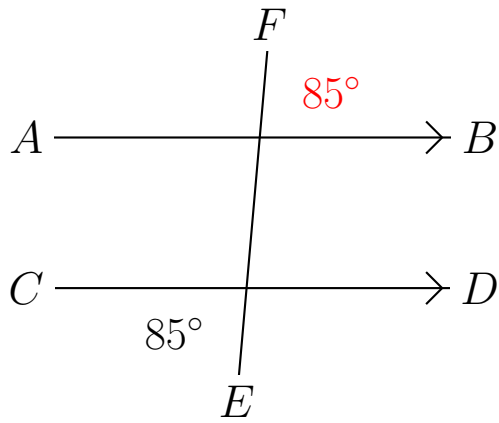

# Problemas de Hallar Ángulos (B)

Complete los ángulos que faltan.

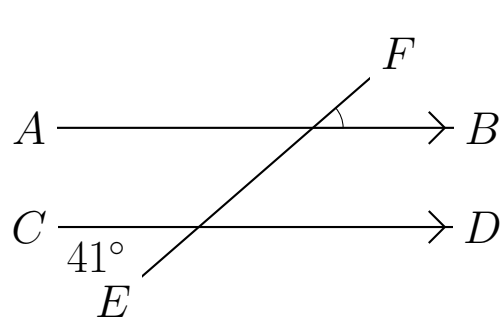
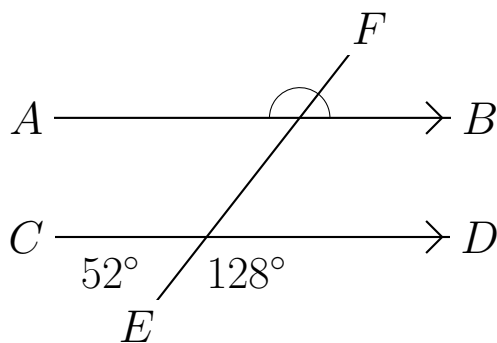
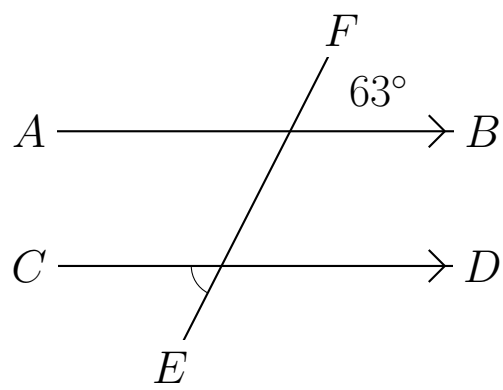
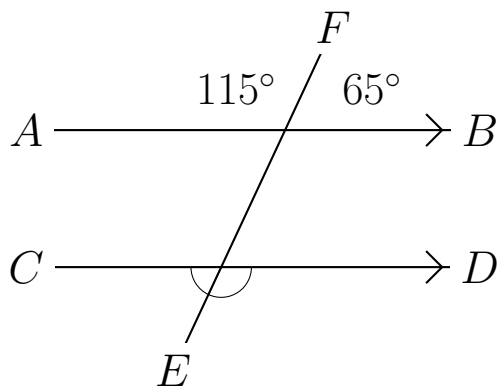
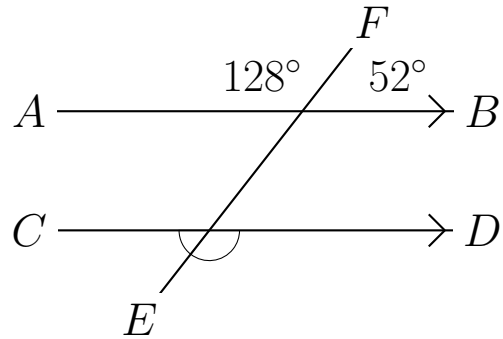
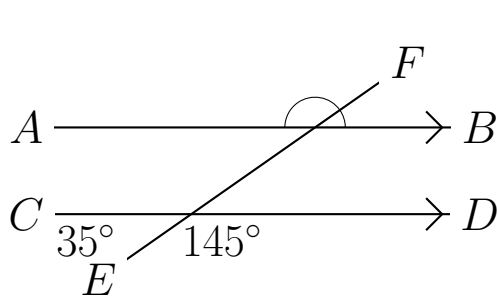

# Problemas de Hallar Ángulos (B) Respuestas

Complete los ángulos que faltan.

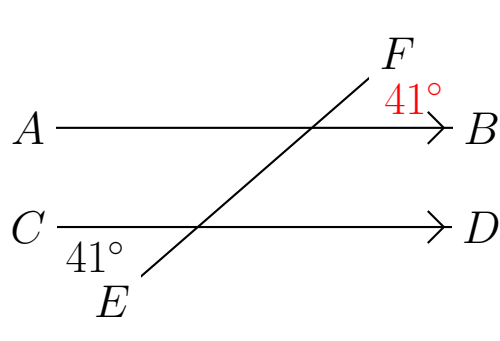
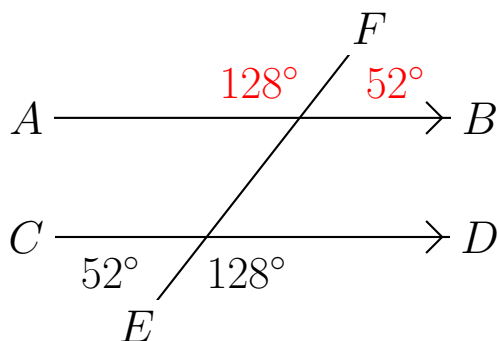
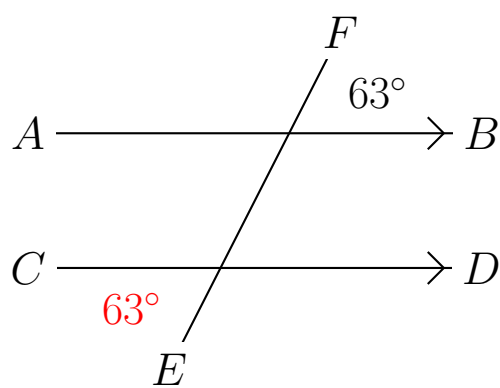
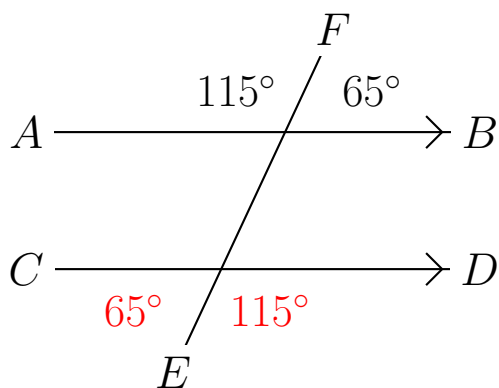
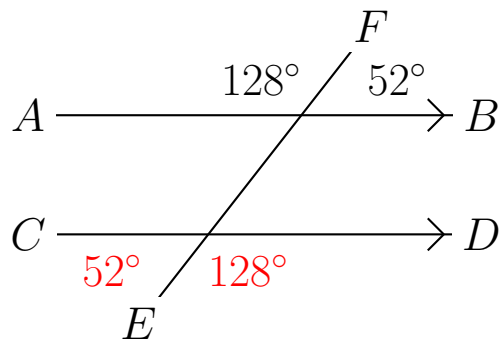
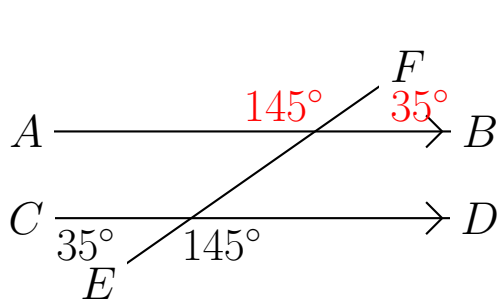

# Problemas de Hallar Ángulos (C)

Complete los ángulos que faltan.

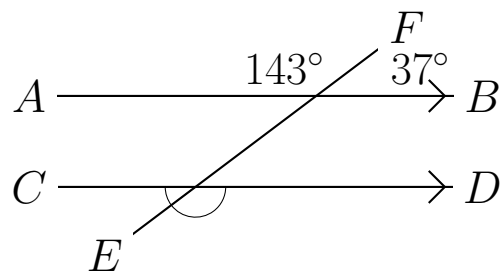
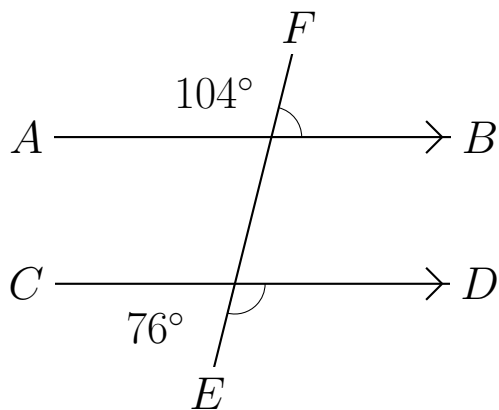
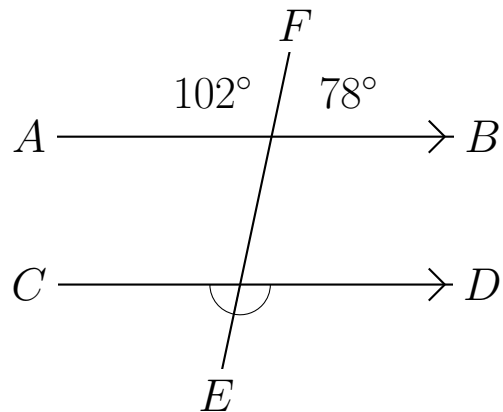
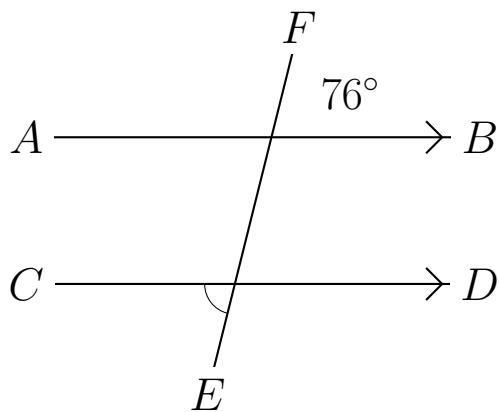
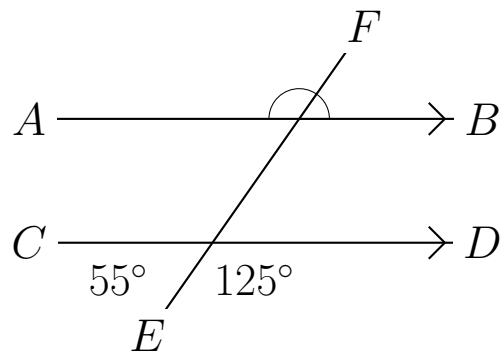
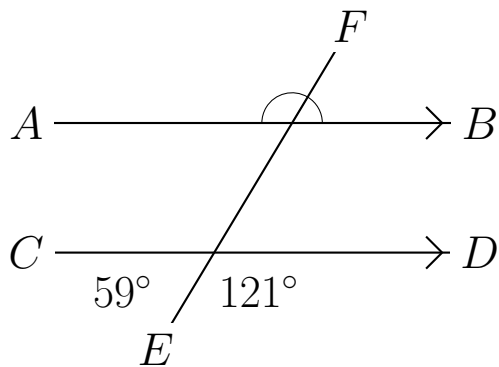

# Problemas de Hallar Ángulos (C) Respuestas

Complete los ángulos que faltan.

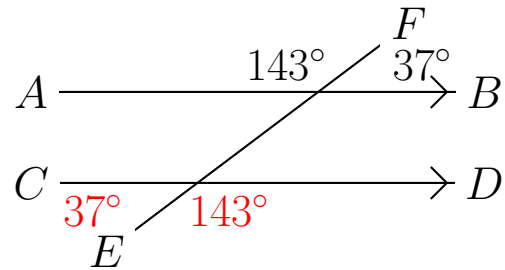
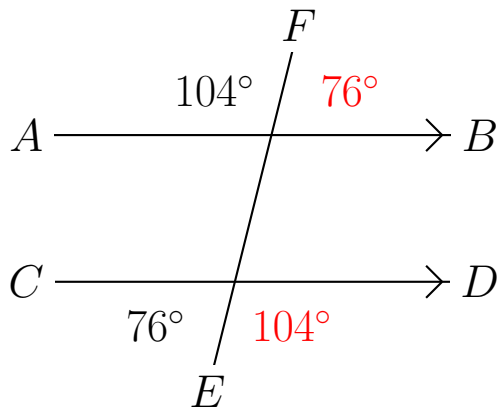
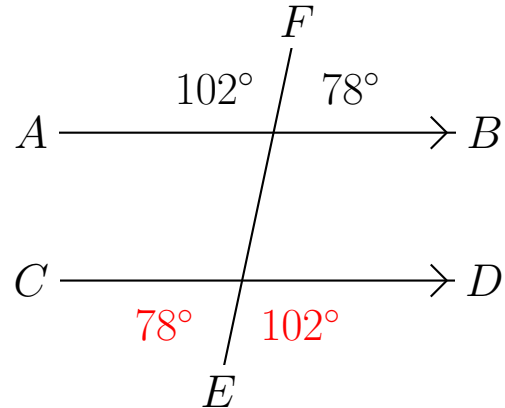
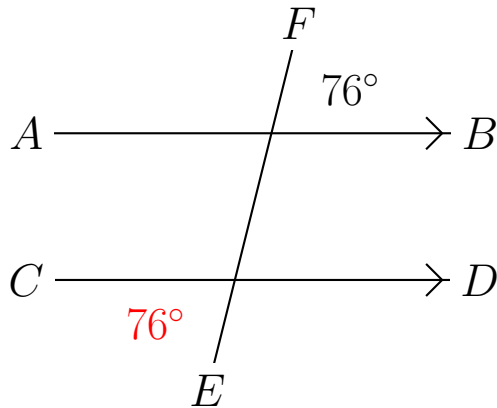
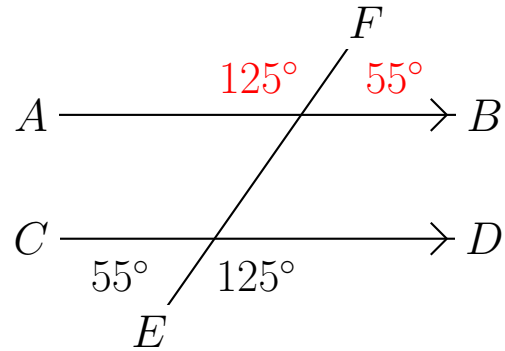
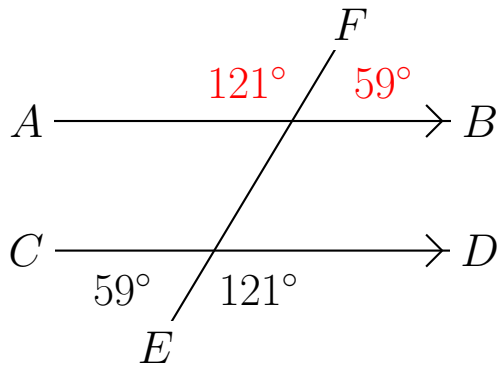

# Problemas de Hallar Ángulos (D)

Complete los ángulos que faltan.

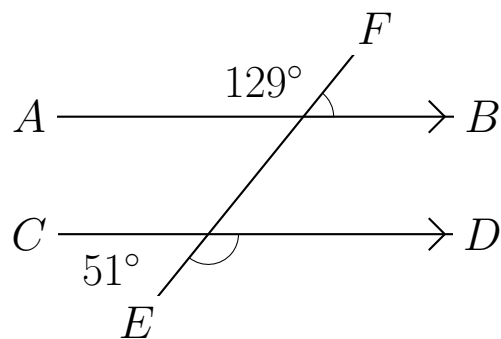
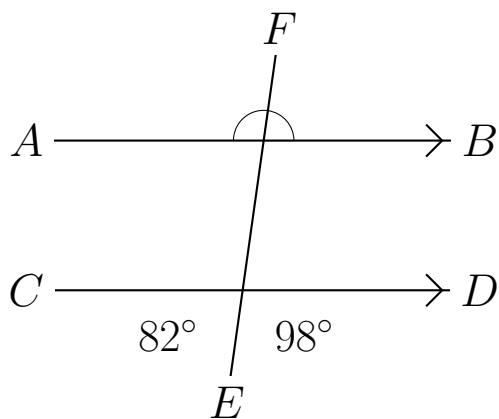
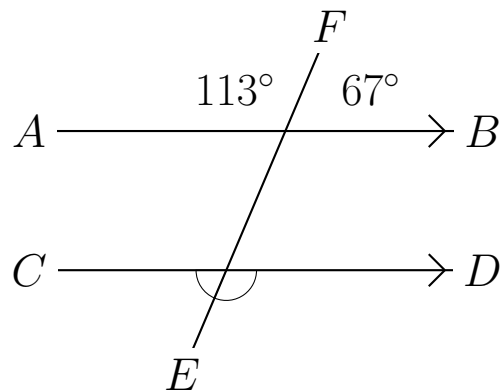
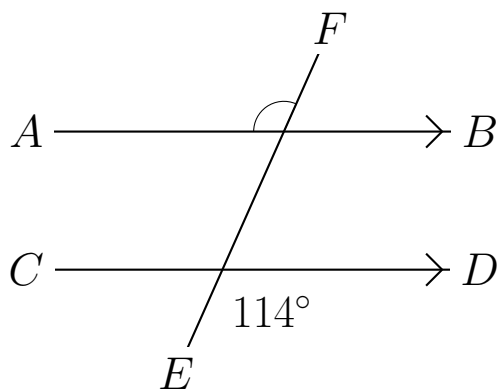
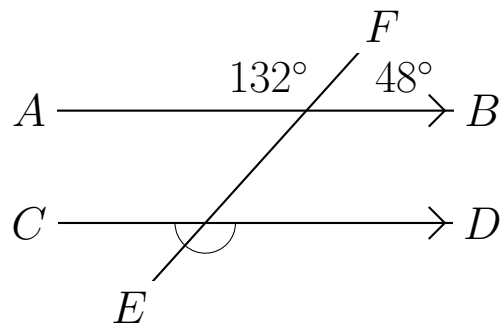
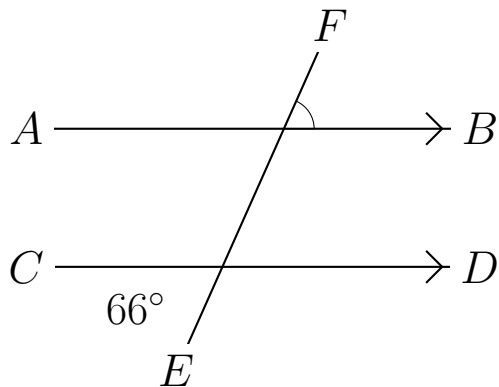

# Problemas de Hallar Ángulos (D) Respuestas

Complete los ángulos que faltan.

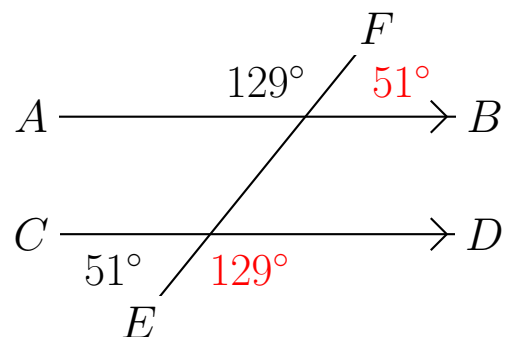
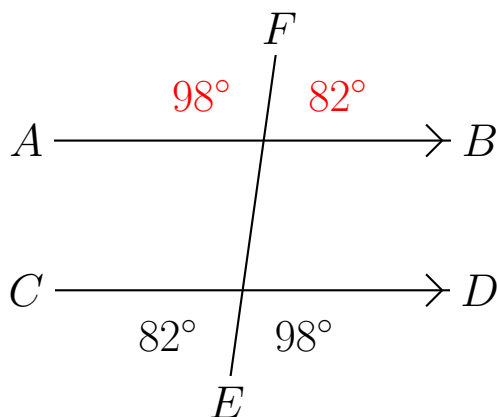
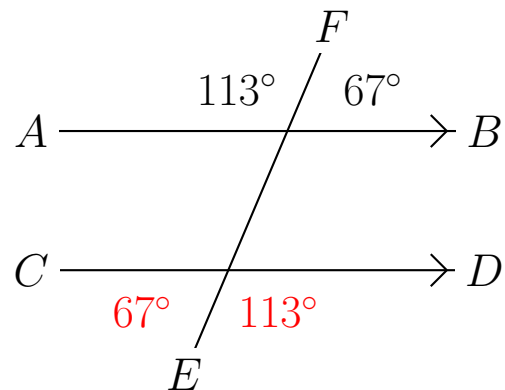
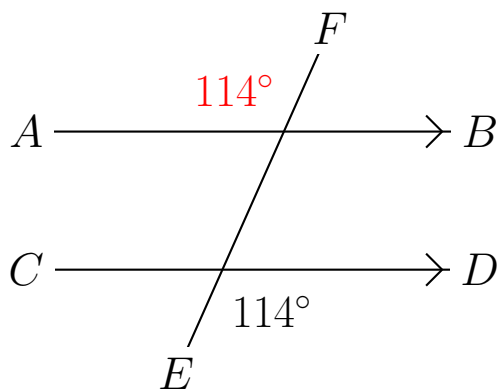
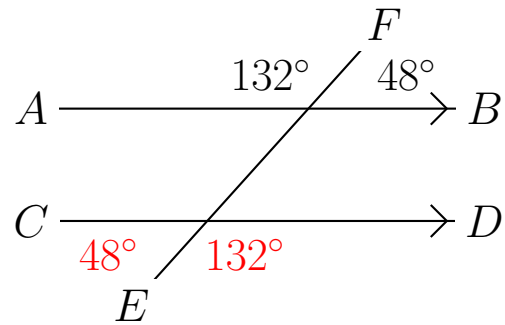
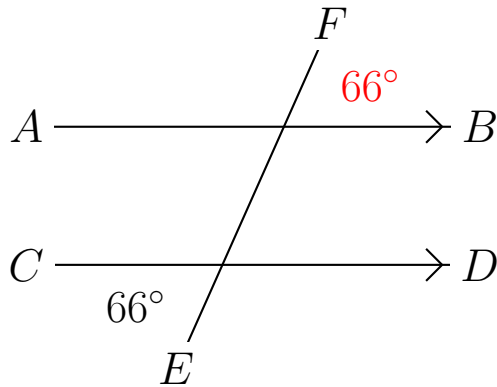



# Problemas de Hallar Ángulos (E)

Complete los ángulos que faltan.

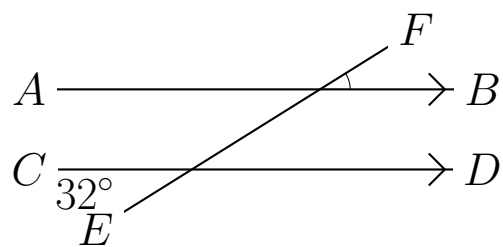
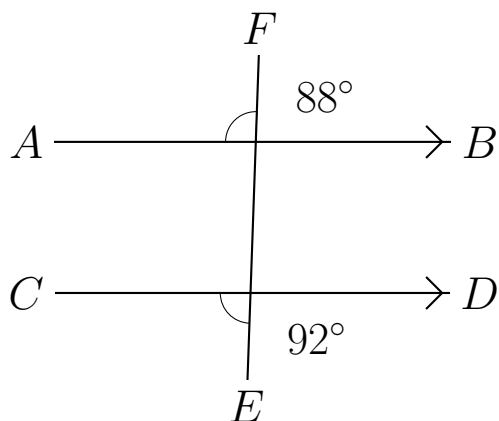
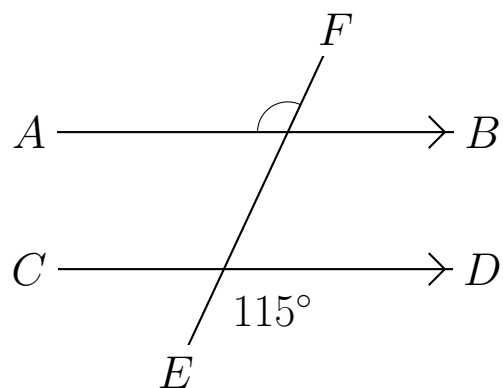
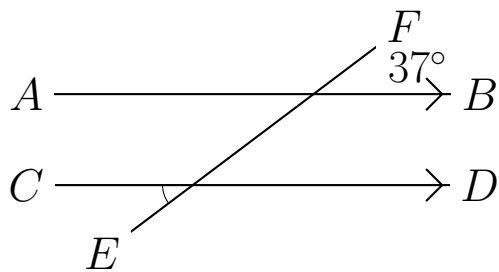
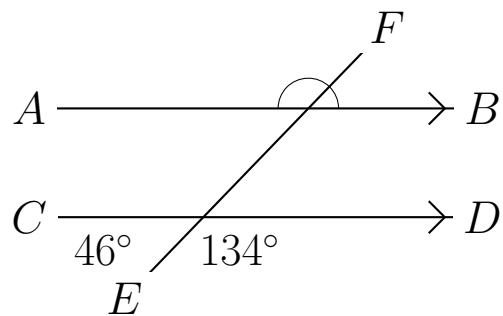
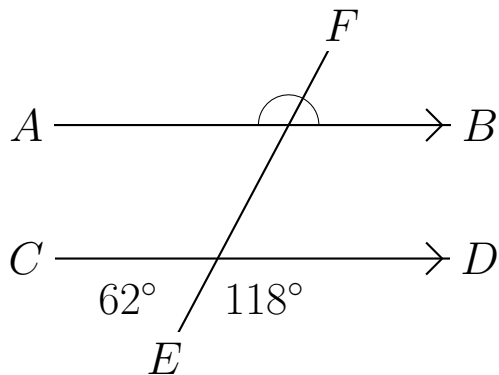

# Problemas de Hallar Ángulos (E) Respuestas

Complete los ángulos que faltan.

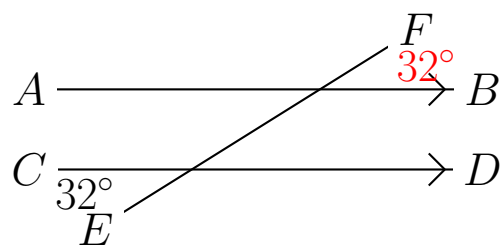
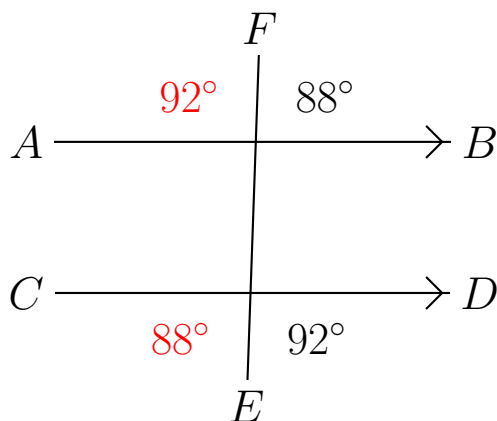
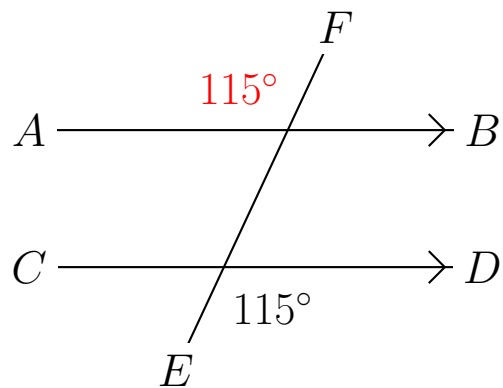
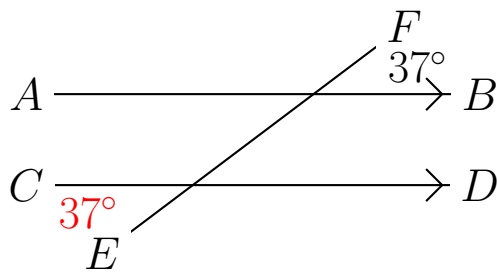
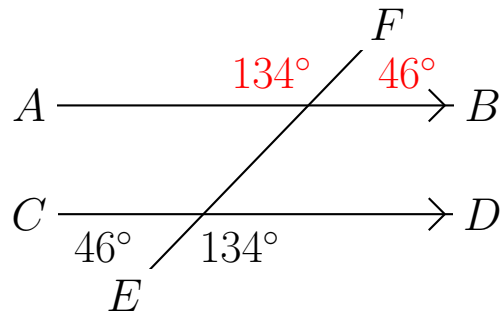
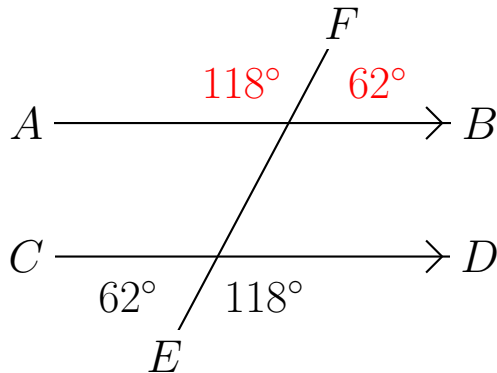

# Problemas de Hallar Ángulos (F)

Complete los ángulos que faltan.

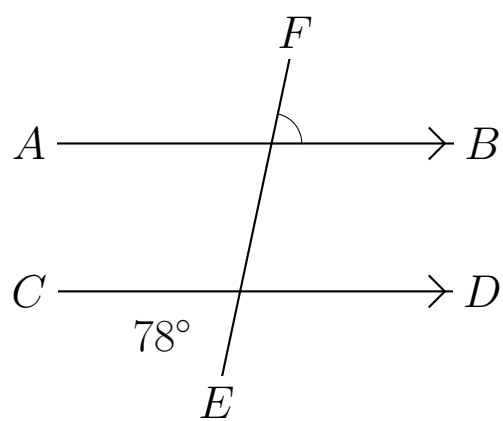
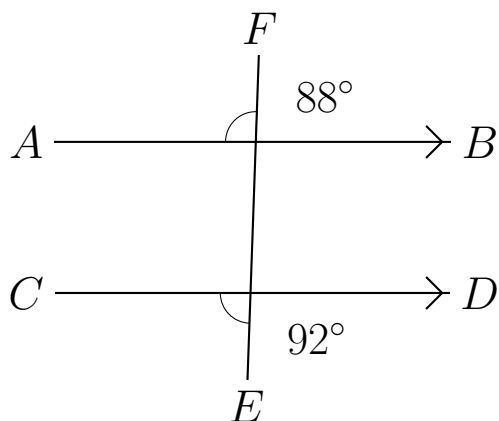
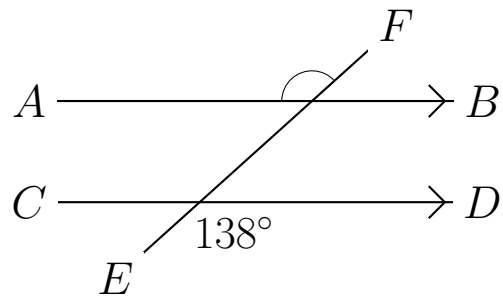
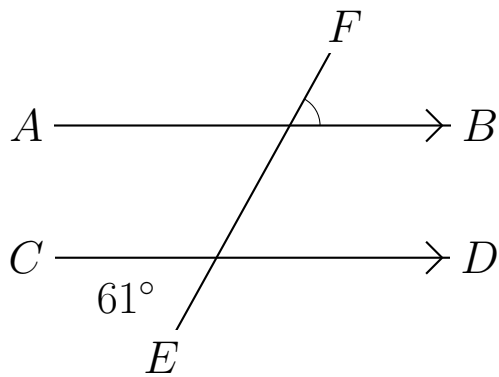
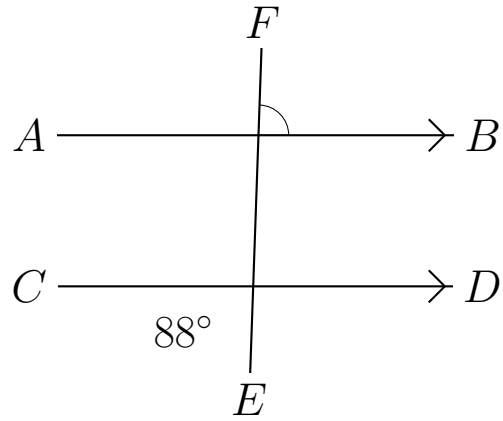
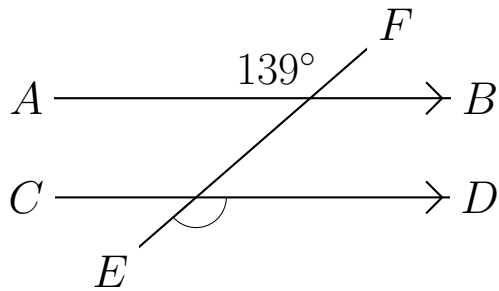

# Problemas de Hallar Ángulos (F) Respuestas

Complete los ángulos que faltan.

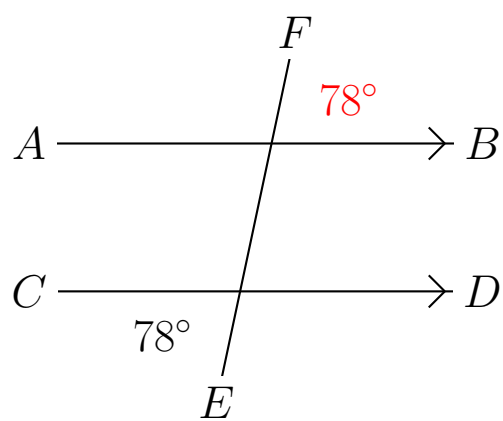
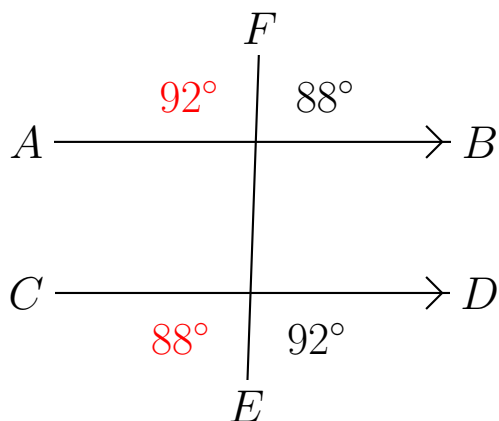
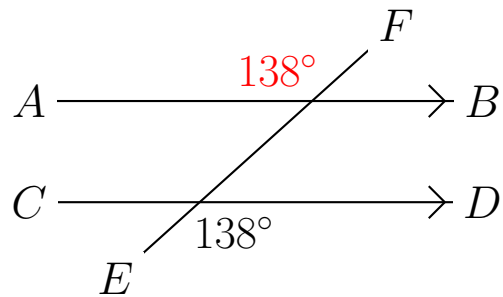
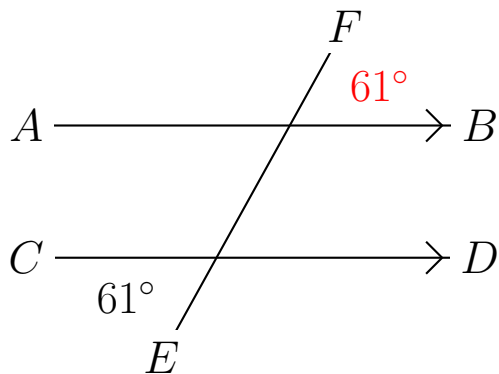
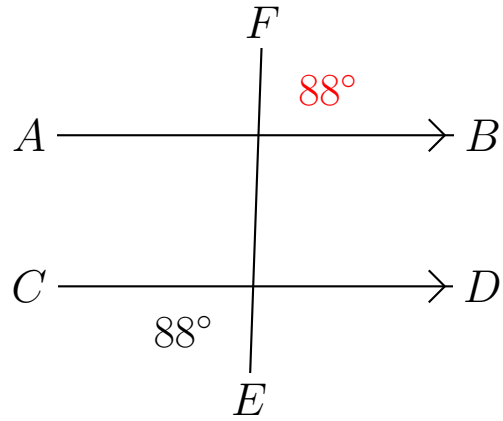
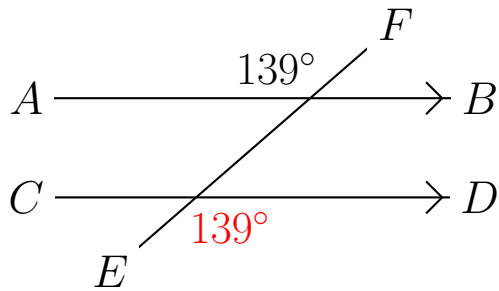

# Problemas de Hallar Ángulos (G)

Complete los ángulos que faltan.

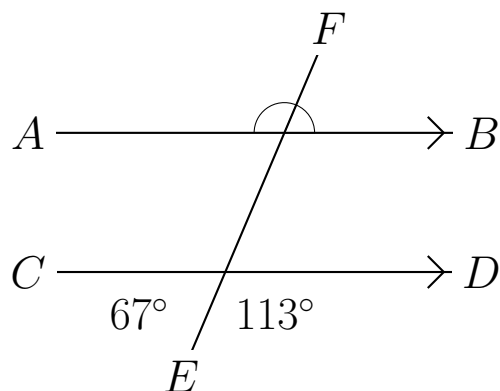
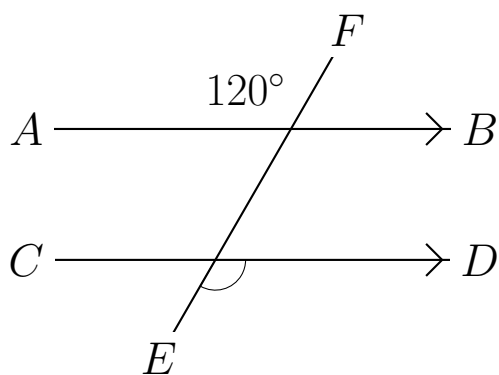
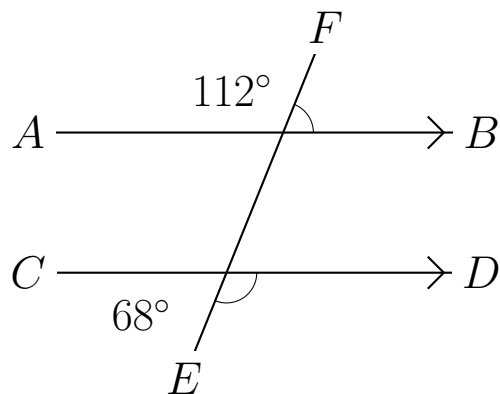
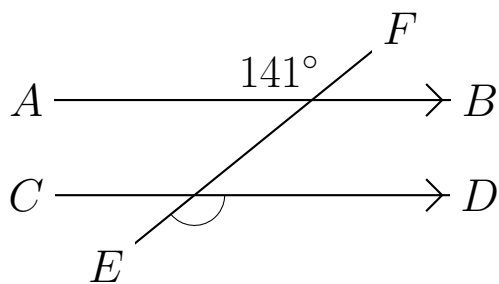
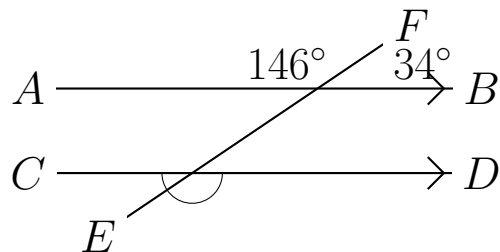
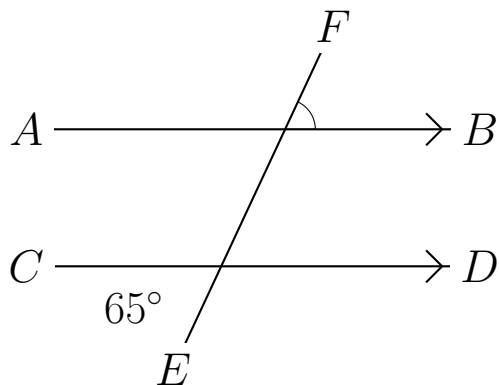

# Problemas de Hallar Ángulos (G) Respuestas

Complete los ángulos que faltan.

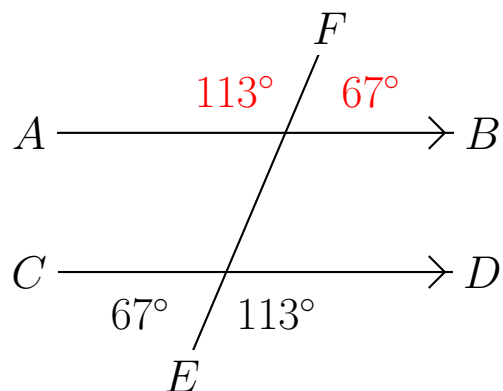
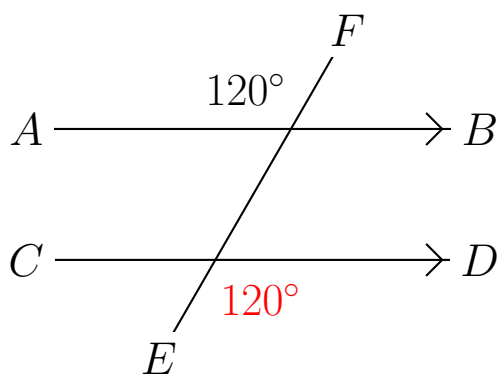
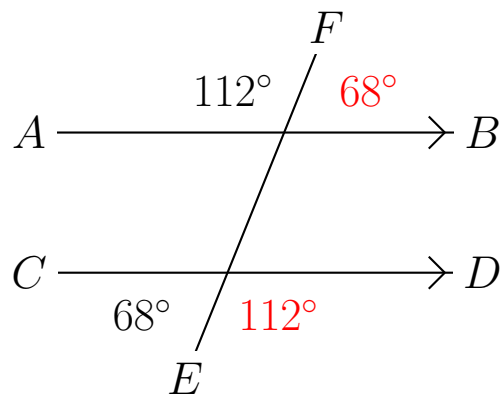
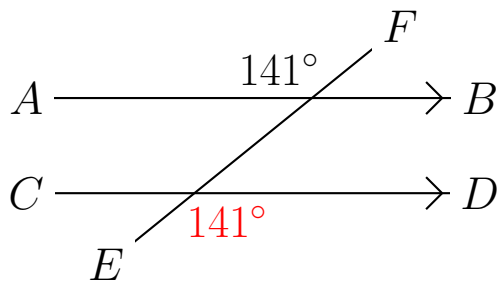
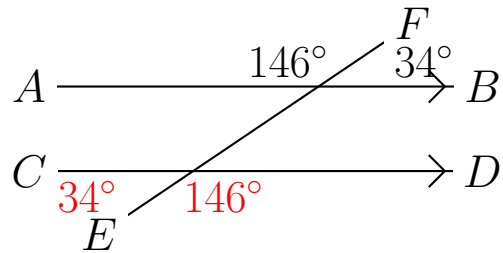
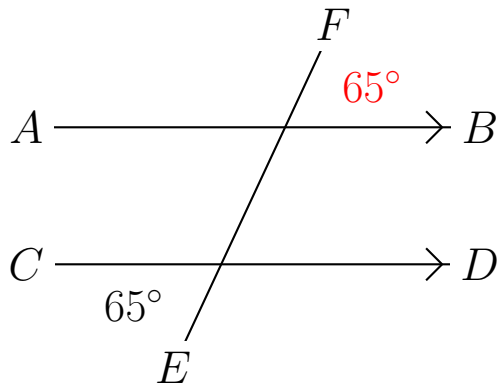

# Problemas de Hallar Ángulos (H)

Complete los ángulos que faltan.

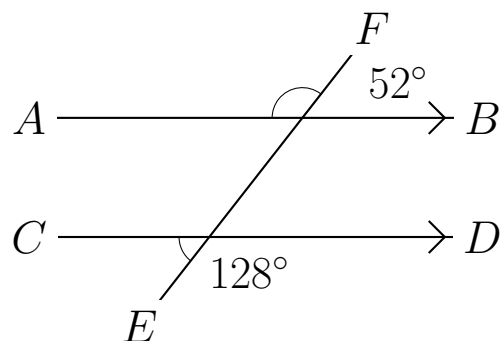
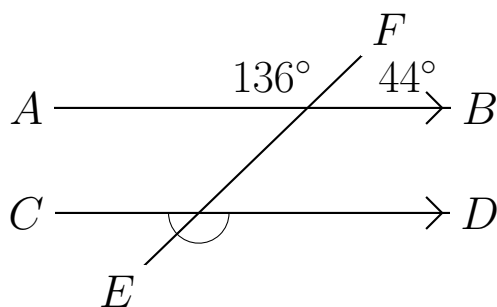
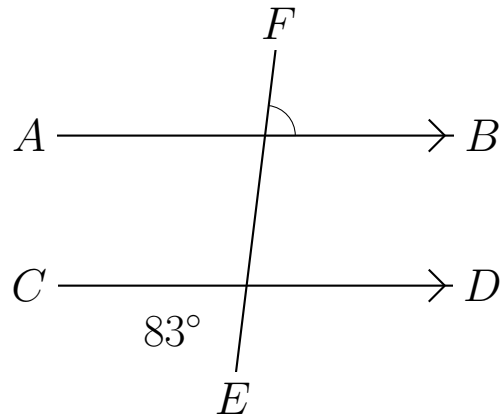
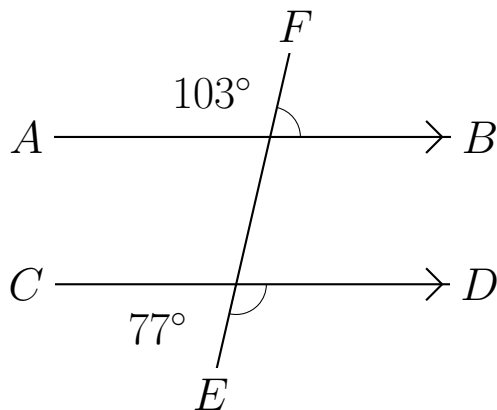
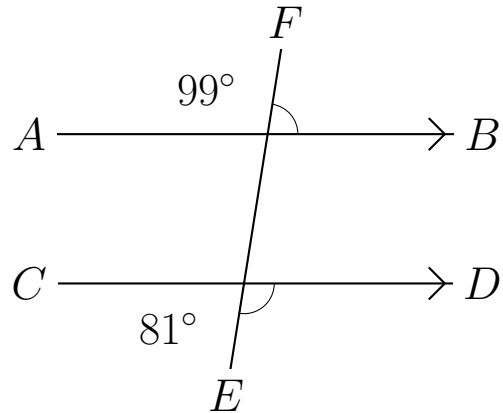
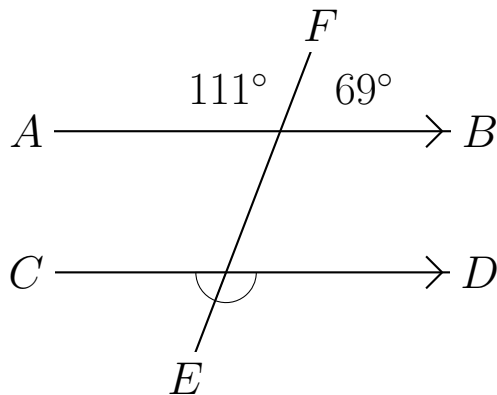

# Problemas de Hallar Ángulos (H) Respuestas

Complete los ángulos que faltan.

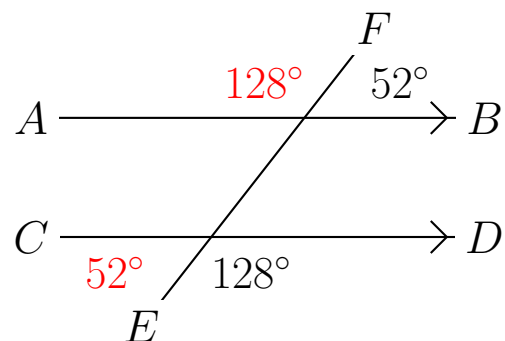
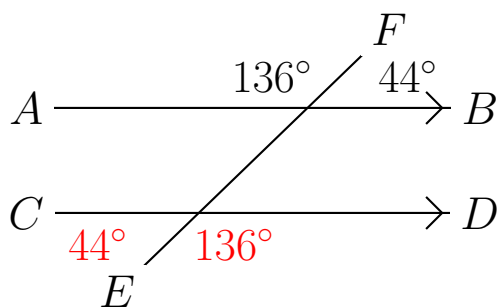
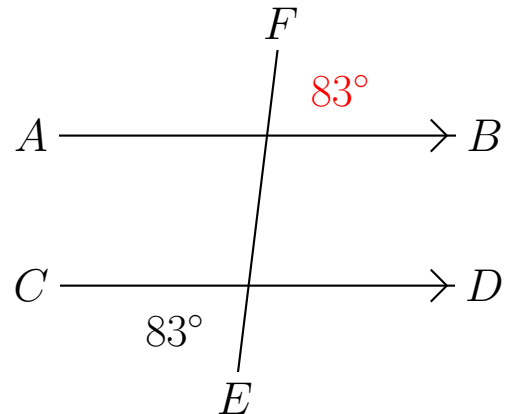
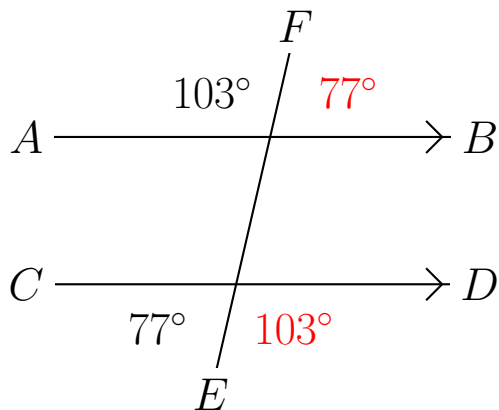
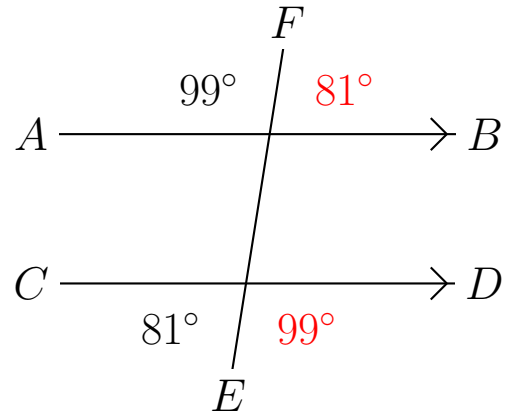
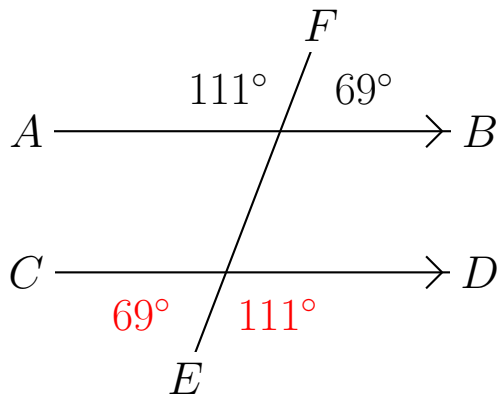



# Problemas de Hallar Ángulos (I)

Complete los ángulos que faltan.

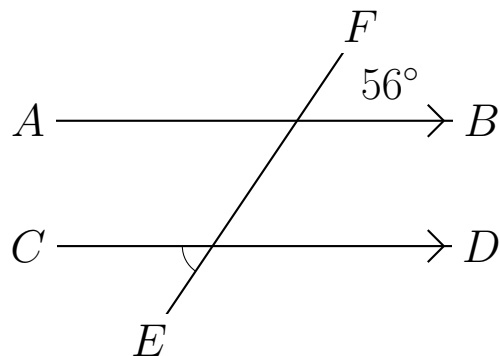
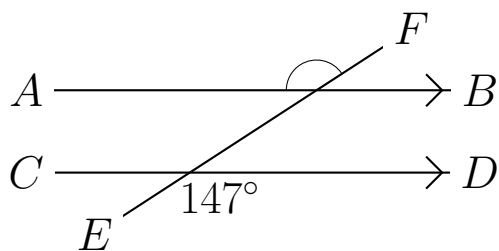
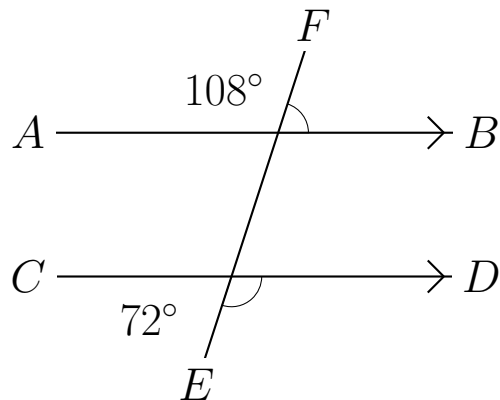
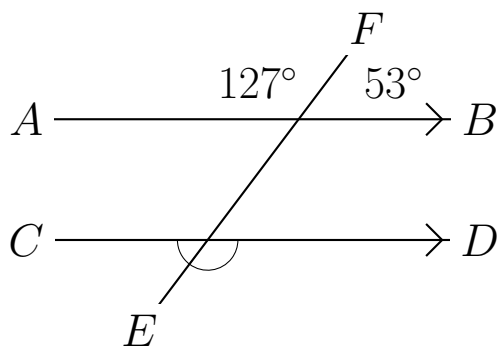
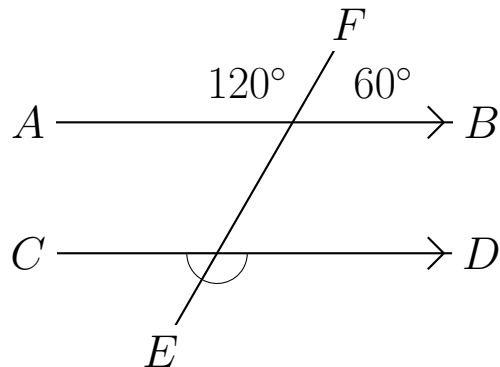
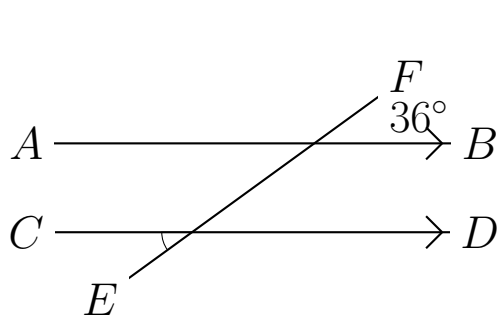

# Problemas de Hallar Ángulos (I) Respuestas

Complete los ángulos que faltan.

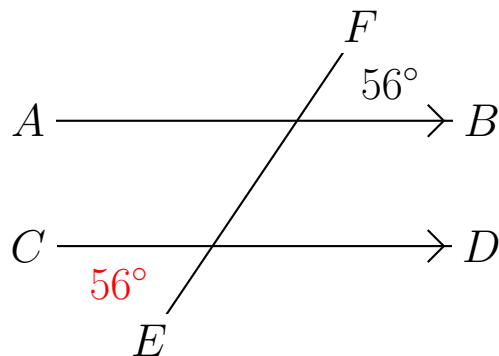
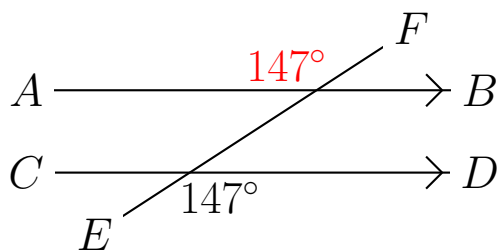
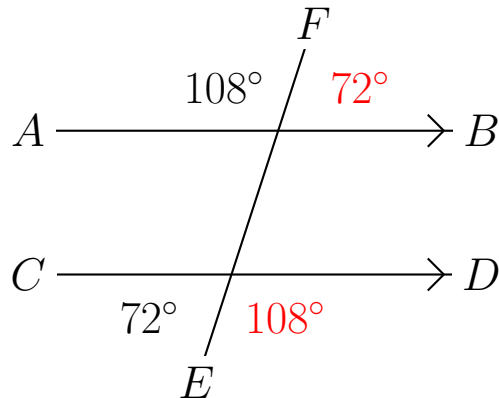
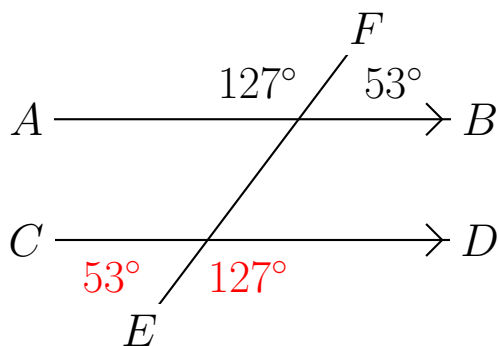
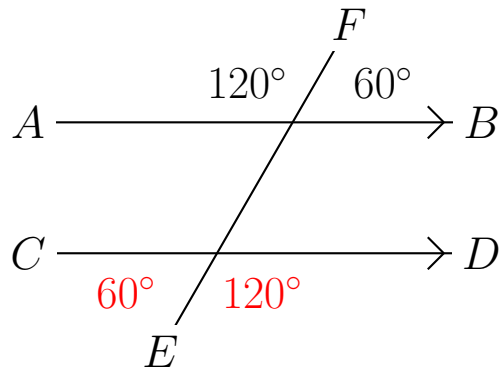
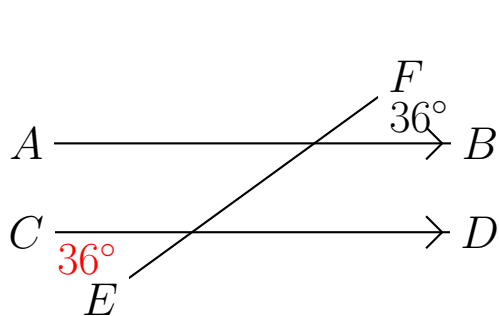

# Problemas de Hallar Ángulos (J)

Complete los ángulos que faltan.

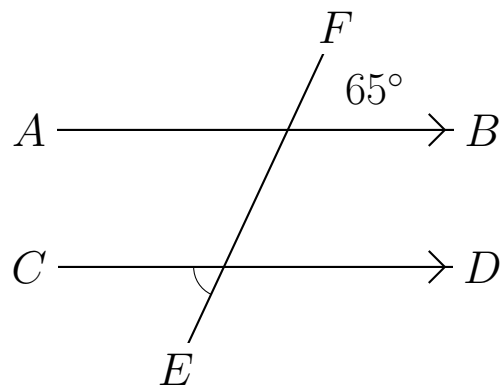
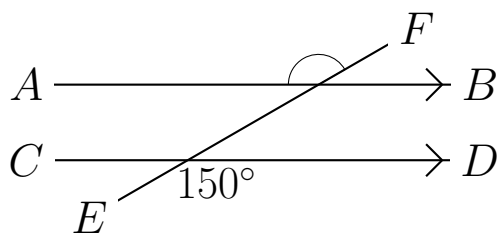
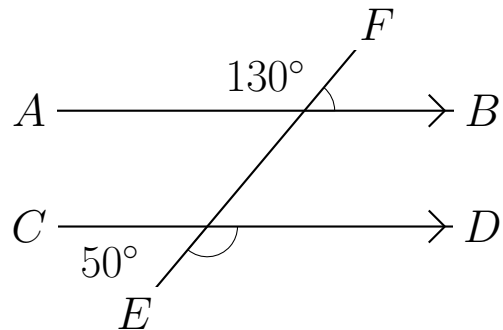
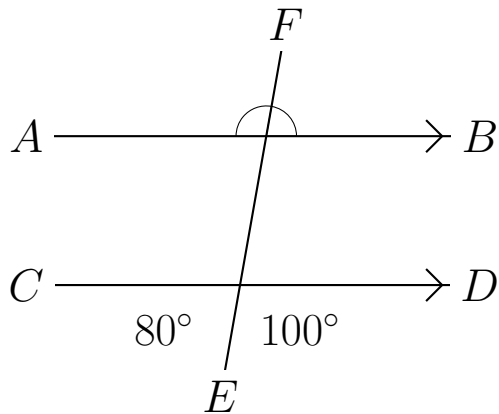
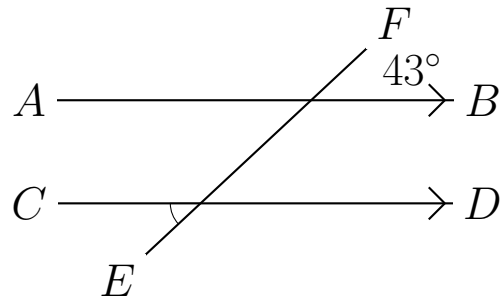
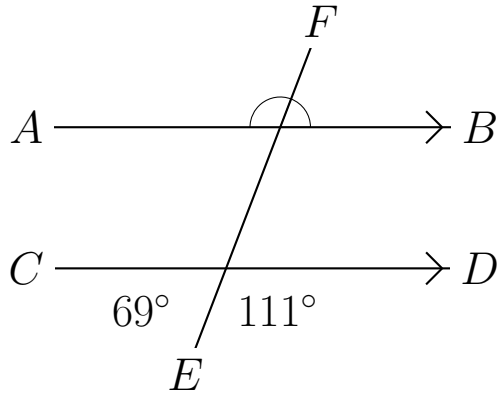

# Problemas de Hallar Ángulos (J) Respuestas

Complete los ángulos que faltan.

